

First Draft of Appendices

**New York Control Area
Installed Capacity
Requirement**

**For the Period May ~~2020~~
2021
To April ~~2021~~2022**



December ~~6xx~~, 20192020

New York State Reliability Council, LLC
Installed Capacity Subcommittee

Table of Contents

A. Reliability Calculation Models and Assumptions..... 3
A.1 GE MARS.....5
A.2 Methodology9
A.3 Base Case Modeling Assumptions10
A.4 MARS Data Scrub42

B. Details for Study Results 46
B.1 Sensitivity Results.....46
B.2 Impacts of Environmental Regulations47
B.3 Frequency of Implementing Emergency Operating Procedures53

C. ICAP to UCAP Translation..... 55
C.1 NYCA and NYC and LI Locational Translations56
C.2 Transmission Districts ICAP to UCAP Translation.....61
C.3 Wind Resource Impact on the NYCA IRM and UCAP Markets69

D. Glossary 71

Table of Tables & Figures

Figure A.1 NYCA ICAP Modeling.....	3
Table A.1 Modeling Details	4
Equation A.1 Transition Rate Definition	6
Equation A.2 Transition Rate Calculation Example.....	6
Table A.2 State Transition Rate Example.....	7
Table A.3 Load Model	10
Table A.4 2020 Final NYCA Peak Load Forecast.....	11
Table A.5 2020 Load Forecast Uncertainty Models	12
Figure A.2 LFU Distributions	13
Table A.6 Capacity Resources	16
Table A.7 Wind Generation.....	19
Figure A.4 Five-Year Zonal EFORds	22
Figure A.5 NYCA Annual Availability by Fuel.....	23
Figure A.6 NYCA Five-Year Availability by Fuel	24
Figure A.7 NERC Annual Availability by Fuel.....	25
Figure A.8 NERC Five-Year Availability by Fuel	26
Figure A.9 Planned and Maintenance Outage Rates	29
Figure A.10 Scheduled Maintenance	30
Table A.8 Transmission System Model.....	32
Figure A.11 2020 IRM Topology.....	34
Figure A.12 Dynamic Interface Ratings Information.....	35
Table A.9 Interface Limits Updates.....	36
Table A.10 External Area Representations	38
Table A.11 Outside World Reserve Margins	39
Table A.12 Assumptions for Emergency Operating Procedures.....	40
Table A.13 Emergency Operating Procedures Values	40
Table A.14 SCR Performance	41
Table A.15 GE MARS Data Scrub.....	43
Table A.16 NYISO MARS Data Scrub	43
Table A.17 Transmission Owner Data Scrub	44
Table B.1 Sensitivity Case Results	47
Table B.2 Implementation of EOP steps	53
Table C.1 Historical NYCA Capacity Parameters	55
Table C.2 NYCA ICAP to UCAP Translation.....	57
Table C.3 New York City ICAP to UCAP Translation	58
Table C.4 Long Island ICAP to UCAP Translation.....	59
Table C.5 GHJ ICAP to UCAP Translation.....	60
Table C.6 Central Hudson Gas & Electric ICAP to UCAP Translation.....	61
Table C.7 Con Ed ICAP to UCAP Translation.....	62

Table C.8 LIPA ICAP to UCAP Translation.....	63
Table C.9 NGRID ICAP to UCAP Translation	64
Table C.10 NYPA ICAP to UCAP Translation	65
Table C.11 NYSEG ICAP to UCAP Translation	66
Table C.12 O & R ICAP to UCAP Translation.....	67
Table C.13 RGE ICAP to UCAP Translation	68

Appendices

Appendix A

NYCA Installed Capacity Requirement Reliability Calculation Models and Assumptions

**Description of the GE MARS Program: Load, Capacity,
Transmission, Outside World Model, and Assumptions**

A. Reliability Calculation Models and Assumptions

The reliability calculation process for determining the NYCA IRM requirement utilizes a probabilistic approach. This technique calculates the probabilities of outages of generating units, in conjunction with load and transmission models, to determine the number of days per year of expected capacity shortages. The General Electric Multi-Area Reliability Simulation (GE-MARS) is the primary computer program used for this probabilistic analysis. The result of the calculation for “Loss of Load Expectation” (LOLE) provides a consistent measure of system reliability. The various models used in the NYCA IRM calculation process are depicted in Figure A.1 below.

Table A.1 lists the study parameters, the source for the study assumptions, and where the assumptions are described in Appendix A. Finally, section A.3 compares the assumptions used in the 2019 and 2020 IRM reports.

Figure A.1 NYCA ICAP Modeling

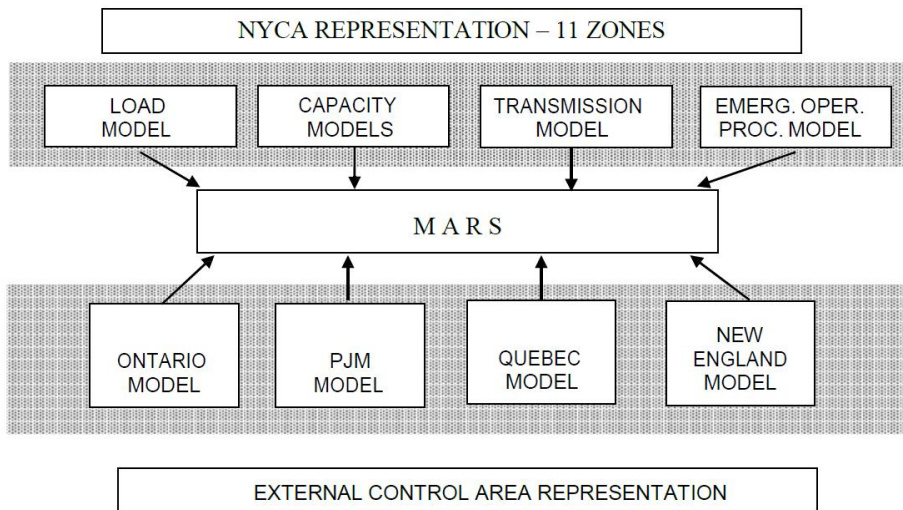

Table A.1 Modeling Details

#	Parameter	Description	Source	Reference
Internal NYCA Modeling				
1	GE MARS	General Electric Multi-Area Reliability Simulation Program		Section A.1
2	11 Zones	Load Areas	Fig A.1	NYISO Accounting & Billing Manual
3	Zone Capacity Models	Generator models for each generating in Zone Generator availability Unit ratings	GADS data 2019 2020 Gold Book ¹	Section A.3.2
4	Emergency Operating Procedures	Reduces load during emergency conditions to maintain operating reserves	NYISO	Section A.3.5
5	Zone Load Models	Hourly loads	NYCA load shape and peak forecasts	Section A.3.1
6	Load Uncertainty Model	Account for forecast uncertainty due to weather conditions	Historical data	Section A.3.1
7	Transmission Capacity Model	Emergency transfer limits of transmission interfaces between Zones	NYISO Transmission Studies	Section A.3.3
External Control Area Modeling				
8	Ontario, Quebec, ISONE, PJM Control Area Parameters	See items 9-12 in this table	Supplied by External Control Area	
9	External Control Area Capacity models	Generator models in neighboring Control Areas	Supplied by External Control Area	Section A.3.4
10	External Control Area Load Models	Hourly loads	Supplied by External Control Area	Section A.3.4
11	External Control Area Load Uncertainty Models	Account for forecast uncertainty due to weather conditions	Supplied by External Control Area	Section A.3.4
12	Interconnection Capacity Models	Emergency transfer limits of transmission interfaces between control areas.	Supplied by External Control Area	Section A.3.3

¹ 2020 Load and Capacity Data Report, http://www.nyiso.com/public/markets_operations/services/planning/documents/index.jsp

A.1 GE MARS

As the primary probabilistic analysis tool used for establishing NYCA IRM requirements, the GE-MARS program includes a detailed load, generation, and transmission representation for 11 NYCA Zones, as well as the four external Control Areas (Outside World Areas) interconnected to the NYCA (see Section A.3 for a description of these Zones and Outside World Areas).

A sequential Monte Carlo simulation forms the basis for GE-MARS. The Monte Carlo method provides a fast, versatile, and easily expandable program that can be used to fully model many different types of generation, transmission, and demand-side options. GE-MARS calculates the standard reliability indices of daily and hourly LOLE (days/year and hours/year) and Loss of Energy Expectation (LOEE in MWh/year). The use of sequential Monte Carlo simulation allows for the calculation of time-correlated measures such as frequency (outages/year) and duration (hours/outage). The program also calculates the need for initiating Emergency Operating Procedures (EOPs), expressed in days/year (see Section A.3.5).

In addition to calculating the expected values for the reliability indices, GE-MARS also produces probability distributions that show the actual yearly variations in reliability that the NYCA could be expected to experience. In determining NYCA reliability, there are several types of randomly occurring events that must be taken into consideration. Among these are the forced outages of generating units and transmission capacity. Monte Carlo simulation models the effects of such random events. Deviations from the forecasted loads are captured using a load forecast uncertainty model.

Monte Carlo simulation approaches can be categorized as “non-sequential” and “sequential”. A non-sequential simulation process does not move through time chronologically or sequentially, but rather considers each hour independent of every other hour. Because of this, non-sequential simulation cannot accurately model issues that involve time correlations, such as maintenance outages, and cannot be used to calculate time-related indices such as frequency and duration.

Sequential Monte Carlo simulation (used by GE-MARS) steps through the year chronologically, recognizing the status of equipment is not independent of its status in adjacent hours. Equipment forced outages are modeled by taking the equipment out of service for contiguous hours, with the length of the outage period being determined from the equipment’s mean time to repair. Sequential simulation can

model issues of concern that involve time correlations and can be used to calculate indices such as frequency and duration. It also models transfer limitations between individual areas.

Because the GE-MARS Program is based on a sequential Monte Carlo simulation, it uses state transition rates, rather than state probabilities, to describe the random forced outages of the thermal units. State probabilities give the probability of a unit being in a given capacity state at any particular time and can be used if one assumes that the unit's capacity state for a given hour is independent of its state at any other hour. Sequential Monte Carlo simulation recognizes the fact that a unit's capacity state in any given hour is dependent on a given state in previous hours and influences its state in future hours. It thus requires additional information that is contained in the transition rate data.

For each unit, a transition rate matrix is input that shows the transition rates to go from each capacity state to each other capacity state. The transition rate from state A to state B is defined as the number of transitions from A to B per unit of time in state A (Equation A.1).

Equation A.1 Transition Rate Definition

$$\text{Transition (A to B)} = \frac{\text{Number of Transitions from A to B}}{\text{Total Time in State A}}$$

Table A.2 shows the calculation of the state transition rates from historic data for one year. The Time-in-State Data shows the amount of time that the unit spent in each of the available capacity states during the year; the unit was on planned outage for the remaining 760 hours. The Transition Data shows the number of times that the unit transitioned from each state to each other state during the year. The State Transition Rates can be calculated from this data. For example, the transition rate from state 1 to state 2 equals the number of transitions from 1 to 2 divided by the total time spent in state 1 (Equation A.2).

Equation A.2 Transition Rate Calculation Example

$$\text{Transition (1 to 2)} = \frac{(10 \text{ Transitions})}{5,000 \text{ Hours}} = 0.0002$$

Table A.2 State Transition Rate Example

Time in State Data			Transition Data			
State	MW	Hours	From State	To State 1	To State 2	To State 3
1	200	5000	1	0	10	5
2	100	2000	2	6	0	12
3	0	1000	3	9	8	0
State Transition Rates						
From State	To State 1	To State 2	To State 3			
1	0.000	0.002	0.001			
2	0.003	0.000	0.006			
3	0.009	0.008	0.000			

From the state transition rates for a unit, the program calculates the two important quantities that are needed to model the random forced outages on the unit: the average time that the unit resides in each capacity state, and the probability of the unit transitioning from each state to each other state.

Whenever a unit changes capacity states, two random numbers are generated. The first is used to calculate the amount of time that the unit will spend in the current state; it is assumed that the time in a state is exponentially distributed, with a mean as computed from the transition rates. This time in state is added to the current simulation time to calculate when the next random state change will occur. The second random number is combined with the state transition probabilities to determine the state to which the unit will transition when it leaves its current state. The program thus knows for every unit on the system, its current state, when it will be leaving that state, and the state to which it will go next.

Each time a unit changes state, because of random state changes, the beginning or ending of planned outages, or mid-year installations or retirements, the total capacity available in the unit's area is updated to reflect the change in the unit's available capacity. This total capacity is then used in computing the area margins each hour.

A.1.1 Error Analysis

An important issue in using Monte Carlo simulation programs such as GE-MARS is the number of years of artificial history (or replications) that must be created to achieve an acceptable level of statistical convergence in the expected value of the reliability index of interest. The degree of statistical convergence is measured by the standard deviation of the estimate of the reliability index that is calculated from the simulation data.

The standard deviation has the same physical units (*e.g.*, days/year) as the index being estimated, and thus its magnitude is a function of the type of index being estimated. Because the standard deviation can assume a wide range of values, the degree of convergence is often measured by the standard error, which is the standard deviation of the estimated mean expressed as a per unit of the mean.

Convergence can also be expressed in terms of a confidence interval that defines the range in which you can state, with a given level of confidence that the actual value falls within the interval. For example, a range centered on the mean of two standard deviations in each direction (plus and minus) defines a confidence interval of 95%.

For this analysis, the Base Case required 245 replications to converge to a standard error of 0.05 and required 1,185 replications to converge to a standard error of 0.025. For our cases, the model was run to 2,750 replications at which point the daily LOLE of 0.100 days/year for NYCA was met with a standard error less than 0.025. The confidence interval at this point ranges from 18.8% to 19.1%. It should be recognized that an IRM of 18.9% is in full compliance with the NYSRC Resource Adequacy rules and criteria (see Base Case Study Results section).

Commented [A1]: Will need updating

A.1.2 Conduct of the GE-MARS analysis

The study was performed using Version [3.31.1546](#) of the GE-MARS software program. This version has been benchmark tested by the NYISO.

The current base case is the culmination of the individual changes made to last year's base case. Each change, however, is evaluated individually against last year's base case. The LOLE results of each of these pre-base case simulations are reviewed to confirm that the reliability impact of the change is reasonable and explainable.

General Electric was asked to review the input data for errors. They have developed a program called "Data Scrub" which processes the input files and flags data that

appears to be out of the ordinary. For example, it can identify a unit with a forced outage rate significantly higher than all the others in that size and type category. If something is found, the ISO reviews the data and either confirms that it is correct as is or institutes a correction. The results of this data scrub are shown in Section A.4.

The top three summer peak loads of all Areas external to NYCA are aligned to be on the same days as that of NYCA, even though they may have historically occurred at different times. This is a conservative approach, using the assumption that peak conditions could be the result of a wide spread heat wave. This would result in reducing the amount of assistance that NYCA could receive from the other Areas.

A.2 Methodology

The ~~2020–2021~~ IRM study continues to use the Unified Methodology that simultaneously provides a basis for the NYCA installed reserve requirements and the preliminary locational installed capacity requirements. The IRM/preliminary LCR characteristic consists of a curve function, “a knee of the curve” and straight-line segments at the asymptotes. The curve function is represented by a quadratic (second order) curve which is the basis for the Tan 45 inflection point calculation. Inclusion of IRM/preliminary LCR point pairs remote to the “knee of the curve” may impact the calculation of the quadratic curve function used for the Tan 45 calculation.

The procedure for determining the best fit curve function used for the calculation of the Tan 45 inflection point to define the base case requirement is based on the following methodology:

- 1) Start with all points on IRM/preliminary LCR Characteristic.
- 2) Develop regression curve equations for all different point to point segments consisting of at least four consecutive points.
- 3) Rank all the regression curve equations based on the following:
 - Sort regression equations with highest R2.
 - Remove any equations which show a negative coefficient in the first term. This is the constant labeled ‘a’ in the quadratic equation: ax^2+bx+c
 - Ensure calculated IRM is within the selected point pair range, i.e., if the curve fit was developed between 14% and 18% and the calculated IRM is 13.9%, the calculation is invalid.
 - In addition, there must be at least one statewide reserve margin point to the left and right of the calculated tan 45 point.

- Ensure the calculated IRM and corresponding preliminary LCR do not violate the 0.1 LOLE criteria.
- Check results to ensure they are consistent with visual inspection methodology used in past years’ studies.

This approach identifies the quadratic curve functions with highest R² correlations as the basis for the Tan 45 calculation. The final IRM is obtained by averaging the Tan 45 IRM points of the NYC and LI curves. The Tan 45 points are determined by solving for the first derivatives of each of the “best fit” quadratic functions as a slope of -1. Lastly, the resulting preliminary LCR values are identified.

A.3 Base Case Modeling Assumptions

A.3.1 Load Model

Table A.3 Load Model

Parameter	2020 Study Assumption	2021 Study Assumption	Explanation
Peak Load	October 1, 2019 NYCA: 32,169 MW NYC: 11,512 MW LI: 5,216 MW G-J: 15,776 MW	October 1, 2020 NYCA: NYCA: 32,243.0 MW NYC: 11,232.3 MW LI: 5,282.0 MW G-J: 15,385.3 MW	Forecast based on examination of 2020 weather normalized peaks, 2021 economic and expected weather projections, and Transmission Owner projections.
Load Shape Model	Multiple Load Shapes Model using years 2002 (Bin 2), 2006 (Bin 1), and 2007 (Bin 3-7)	Multiple Load Shapes Model using years 2002 (Bin 2), 2006 (Bin 1), and 2007 (Bin 3-7)	No Change
Load Uncertainty Model	Statewide and zonal models updated to reflect current data	Statewide and zonal models updated to reflect current data	Updated from 2020 IRM. Based on TO and NYISO data and analyses.

(1) Peak Load Forecast Methodology

[The procedure for preparing the IRM forecast is very similar to that detailed in the NYISO Load Forecasting Manual for the ICAP forecast. The NYISO's Load Forecasting Task Force had one meeting in September 2020 to review weather-adjusted peaks for the summer of 2020 prepared by the NYISO and the Transmission Owners. Regional load growth factors \(RLGFs\) for 2021 were reviewed and updated by most Transmission Owners; otherwise](#)

the 2021 NYISO RLGs that were used. The 2021 forecast was produced by applying the RLGs to each TO's weather-normalized peak for the summer of 2020.

The results of the analysis are shown in Table A-4. The actual peak of 30,450 MW (col. 2) occurred on July 27, 2020 for the hour beginning 17:00. After accounting for the impacts of weather and other factors, the weather-adjusted peak load was determined to be 31,592 MW (col. 6), 704 MW (2.2%) below the 2020 forecast. The forecast Con Edison transmission district was over forecast by 979MW (7.5%). All other transmission district peaks were over forecast. Most of the forecast error can be attributed to the significant impacts of the COVID-19 pandemic on load during the summer of 2020.

The Regional Load Growth Factors are shown in column 9. The 2021 peak forecast was 32,145 MW (col. 8), prior to adjustments for Behind the Meter Net Generation resources (BTM:NG). The 2020 forecast for the NYCA is 32,243 MW (col. 10). The Locality forecasts are also reported in the second table below.

The LFTF recommended this forecast to the NYSRC for its use in the 2021 IRM study.

Table A.4 2021 Final NYCA Peak Load Forecast

2021 IRM Coincident Peak Forecast by Transmission District for NYSRC											
(1)	(2)	(3)	(4)	(5)	(6a)	(6b)	(6c)	(7)	(8)=(6a)*(7)	(9)	(10)=(8)+(9)
Transmission District	2020 Actual MW	Demand Response Estimate MW	2020 Estimated Muni Self-Gen	Total Weather Adjustment MW	2020 Weather Normalized MW	Loss Reallocation MW	2020 WN MW, Adj for Losses	Regional Load Growth Factors	2021 Forecast, Before Adjustments	BTM:NG and Other Adjustments to Load	2021 IRM Final Forecast
Con Edison	11,273	177	0	605	12,055	0	12,055	1.0492	12,649	21.3	12,670.3
Cen Hudson	1,093	0	0	15	1,108	0	1,108	0.9910	1,098		1,098.0
LIPA	5,344	20	7	-181	5,190	0	5,190	0.9948	5,162	42.0	5,204.0
NGrid	6,702	186	48	36	6,972	0	6,972	1.0026	6,991	2.7	6,993.7
NYPA	405	0	0	-1	404	0	404	1.0262	415		415.0
NYSEG	3,178	54	0	-17	3,215	0	3,215	1.0031	3,225	32.0	3,257.0
O&R	1,038	11	0	36	1,085	0	1,085	0.9914	1,076		1,076.0
RG&E	1,417	8	0	137	1,562	0	1,562	0.9785	1,529		1,529.0
Total	30,450	456	55	631	31,592	0	31,592	1.0175	32,145	98.0	32,243.0
									2021 Forecast from 2020 Gold Book		32,129
									Change from 2020 Gold Book		16
2021 IRM Locality Peak Forecasts by Transmission District for NYSRC											
(1)	(2)	(3)	(4)	(5)	(6)	(7)	(8)	(9)	(10)	(11)	(12)=(8)+(11)
Locality	2020 Actual MW	Demand Response Estimate MW	2020 Estimated Muni Self-Gen	Locality Weather Adjustment MW	2020 Weather Normalized MW	Regional Load Growth Factors	2021 Forecast, Before Adjustments	2021 Forecast from 2020 Gold Book	Change from Gold Book Forecast	BTM:NG and Other Adjustments to Load	2021 IRM Final Forecast
Zone J - NYC	10,061	0	0	624	10,685	1.0492	11,211	11,460	-249	21.3	11,232.3
Zone K - LI	5,428	20	7	-187	5,268	0.9948	5,240	5,139	101	42.0	5,282.0
Zone GHJ	14,057	0	0	726	14,783	1.0393	15,364	15,660	-296	21.3	15,385.3

(1) Zonal Load Forecast Uncertainty

The 2021 load forecast uncertainty (LFU) models were updated during the spring of 2020, since the weather experienced in 2019 was at or above normal conditions. The NYISO developed models for Zones A through I and reviewed the Zone J and Zone K models prepared by LIPA and Con Ed respectively. NYISO models were compared with independent Con Ed and LIPA models to ensure that the LFU results were consistent. Con Ed and LIPA both agreed with the final LFU models presented at LFTF and ICS; the ICS approved the LFU model results. The results of these models are presented in Table A-5. Each row represents the probability that a given range of load levels will occur, on a per-unit basis, by zone. These results are presented graphically in Figure A.2.

Table A.5 ~~2020-2021~~ Summer and Winter Load Forecast Uncertainty Models

LFU 2021						
Bin	Probability	A-E	F&G	H&I	J	K
B1	0.62%	116.02%	117.17%	113.56%	110.73%	116.38%
B2	6.06%	111.11%	111.70%	109.46%	107.33%	111.97%
B3	24.17%	105.70%	105.70%	104.06%	102.89%	105.98%
B4	38.30%	100.00%	99.36%	97.68%	97.67%	100.00%
B5	24.17%	94.22%	92.89%	90.66%	91.91%	91.88%
B6	6.06%	88.58%	86.48%	83.35%	85.86%	82.34%
B7	0.62%	83.28%	80.33%	76.06%	79.79%	75.52%

Delta	A-E	F&G	H&I	J	K
B1 - B4	16.02%	17.80%	15.88%	13.06%	16.38%
B4 - B7	16.72%	19.04%	21.62%	17.88%	24.48%
Total Range	32.74%	36.84%	37.50%	30.94%	40.87%

Zones(s): NYCA (Winter)					
Bin	Probability	Wthr	MW	LFU (2021)	LFU (2020)
B1	0.62%	53.75	25,593	112.22%	111.80%
B2	6.06%	47.98	24,577	107.77%	107.52%
B3	24.17%	42.20	23,648	103.69%	103.59%
B4	38.30%	36.43	22,806	100.00%	100.00%
B5	24.17%	30.66	22,051	96.69%	96.75%
B6	6.06%	24.89	21,383	93.76%	93.85%
B7	0.62%	19.12	20,802	91.22%	91.28%
Design		36.43	22,806		

Figure A.2 LFU Distributions

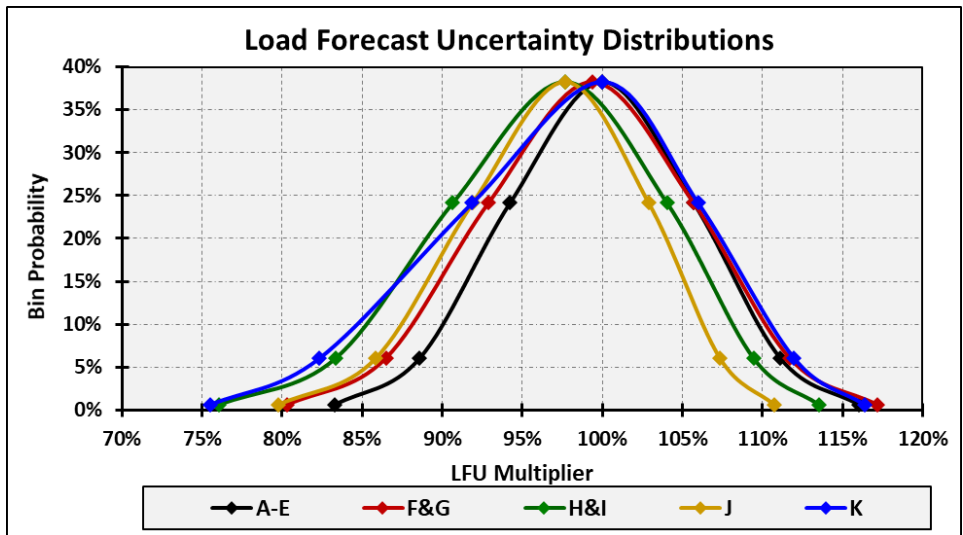

The Consolidated Edison models for Zones H, I & J are based on a peak demand with a 1-in-3 probability of occurrence (67th percentile). All other zones are designed at a 1-in-2 probability of occurrence of the peak demand (50th percentile). The methodology and results for determining the [2020-2021](#) LFU models have been reviewed by the NYISO Load Forecasting Task Force.

Discussion of the ~~2020-2021~~LFU Models

The Load Forecast Uncertainty (LFU) models are meant to measure the load response to weather at high peak-producing temperatures as well as other factors such as the economy. However, economic uncertainty is relatively small compared to temperature uncertainty one year ahead. As a result, the LFTF, the NYISO, and the ICS have agreed that it is sufficient to confine the LFU for the 1-year ahead IRM study only to weather. Thus, the LFU is largely based on the slope of load vs. temperature, or the weather response of load. If the weather response of load increases, the slope of load vs. temperature will increase, and the upper-bin LFU multipliers (Bins 1-3) will increase. The new LFU multipliers included summer 2018 and 2019 data, which was not included in the prior LFU models. In general, the load response to weather in 2018 and 2019 was steeper than it was in previous hot summers.

2018 and 2019 summer weekday base load in most areas declined relative to earlier years. This decline was larger than the decline in summer peak load over the same period. Thus, a contributing factor to increase in slope of load versus weather is due to a downward trend in baseload. This also contributed to larger LFU multipliers in the upper bins.

The recent year-over-year decline in the ICAP load forecast is a mitigating factor which somewhat offsets the increase in LFU. Even though the LFU multipliers and the resultant IRM percent will increase, the peak load used as the starting point to calculate the final MW capacity requirement continues to decrease.

(2) Zonal Load Shape Models for Load Bins

Beginning with the 2014 IRM Study, multiple load shapes were used in the load forecast uncertainty bins. Three historic years were selected from those available, as discussed in the NYISO's 2013 report, 'Modeling Multiple Load Shapes in Resource Adequacy Studies'. The year 2007 was assigned to the first five bins (from cumulative probability 0% to 93.32%). The year 2002 was assigned to the next highest bin, with a probability of 6.06%. The year 2006 was assigned to the highest bin, with a probability of 0.62%. The three load shapes for the NYCA as a whole are shown on a per-unit basis for the highest one hundred hours in Figure A.3. The year 2007 represents the load duration pattern of a typical year. The year 2002 represents the load duration pattern of many hours at high load levels. The year 2006 represents the load duration pattern of a heat wave, with a small number of

hours at high load levels followed by a sharper decrease in per-unit values than the other two profiles.

The load duration curves were reviewed as part of the [2021 IRM Study](#). Load duration curves were examined from the period 2002 through [2019](#). It was observed that the year 2012 was similar to the year 2007, the year 2013 was similar to 2006, and the year 2018 was similar to the year 2002. As a result of this review, the ICS accepted the NYISO's recommendation to continue the use of the current three load shapes.

Figure A.3 Per Unit Load Shapes

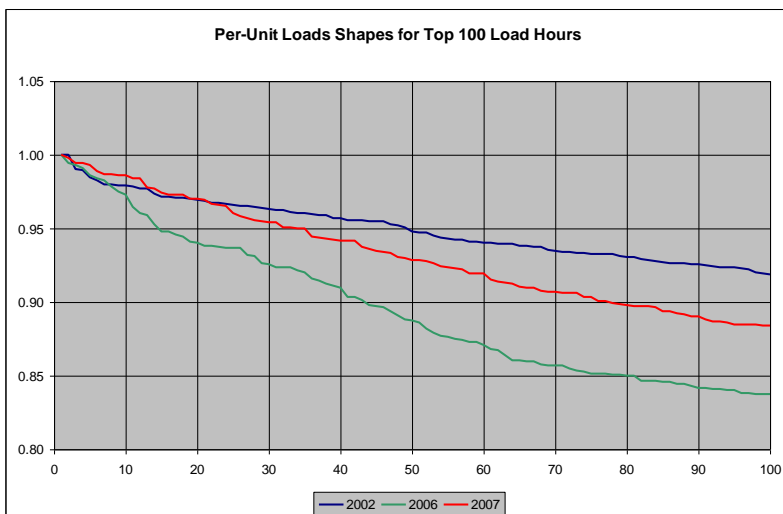

A.3.2 Capacity Model

The capacity model includes all NYCA generating units, including new and planned units, as well as units that are physically outside New York State that have met specific criteria to offer capacity in the New York Control Area. The [2019-2020 Load and Capacity Data Report](#) is the primary data source for these resources. Table A.6 provides a summary of the capacity resource assumptions in the [2020-2021 IRM study](#).

Table A.6 Capacity Resources

Parameter	2019-2020 Study Assumption	2020-2021 Study Assumption	Explanation
Generating Unit Capacities	2018-2019 Gold Book values. Use min (DMNC vs. CRIS) capacity value	2019-2020 Gold Book values. Use min (DMNC vs. CRIS) capacity value	2019-2020 Gold Book publication
Planned Generator Units	1020 MW of new non- wind resources, plus 0 MW of project related re-ratings.	16.0 MW of new Thermal resources, plus 56.6 MW of project related re-ratings.	New resources + Unit rerates
Wind Resources	0 MW of Wind Capacity additions totaling 1891.7 MW of qualifying wind	126.5 MW of Wind Capacity additions totaling 1865.7 MW of qualifying wind	Renewable units based on RPS agreements, interconnection queue, and ICS input.
Wind Shape	Actual hourly plant output over the period 2013 2014- 2017 2018. New units will use zonal hourly averages or nearby units.	Actual hourly plant output over the period 2014 2015- 2018 2019. New units will use zonal hourly averages or nearby units.	Program randomly selects a wind shape of hourly production over the years 2014 2015- 2018 2019 for each model iteration.
Solar Resources (Grid connected)	Total of 34 51.5 MW of qualifying Solar Capacity.	0 MW of Solar Capacity additions totaling 31.5 MW of qualifying Solar Capacity.	ICAP Resources connected to Bulk Electric System
Solar Shape	Actual hourly plant output over the period 2013 2014- 2017 2018. New units will use zonal hourly averages or nearby units.	Actual hourly plant output over the period 2014 2015- 2018 2019. New units will use zonal hourly averages or nearby units.	Program randomly selects a solar shape of hourly production over the years 2014 2015- 2018 2019 for each model iteration.

Parameter	2019-2020 Study Assumption	2020-2021 Study Assumption	Explanation
BTM- NG Program	No new BTM NG resources Forecast load adjustment of 11.6 MW	No One new BTM NG resources Forecast load adjustment of 41.665.2 MW	Both the load and generation of the BTM:NG Resources are modeled.
Retirements, Mothballed units, and ICAP ineligible units	837.0 MW of retirements, 1023.4 MW of unit deactivations, and 0 MW of IIFO and IR	1,104 MW of unit deactivations and 192.788.2 MW of unit removals	2019-2020 Gold Book publication and generator notifications
Forced and Partial Outage Rates	Five-year (2013 2014-20172018) GADS data for each unit represented. Those units with less than five years – use representative data.	Five-year (2014 2015-20182019) GADS data for each unit represented. Those units with less than five years – use representative data.	Transition Rates representing the Equivalent Forced Outage Rates (EFORd) during demand periods over the most recent five-year period (2014 2015-20182019)
Planned Outages	Based on schedules received by the NYISO	Based on schedules received by the NYISO	Updated schedules
Summer Maintenance	Nominal 50 MWs – divided equally between Zones J & K	Nominal 50 MWs – divided equally between Zones J & K	Review of most recent data
Gas Turbine Ambient De-rate	De-rate based on provided temperature correction curves.	De-rate based on provided temperature correction curves.	Operational history indicates de-rates in line with manufacturer's curves

Parameter	2019-2020 Study Assumption	2020-2021 Study Assumption	Explanation
Small Hydro Resources	Actual hourly plant output over the period 2013 2014-20172018.	Actual hourly plant output over the period 20142015-20182019.	Program randomly selects a Hydro shape of hourly production over the years 20142015-2018-2019 for each model iteration.
Large Hydro	Probabilistic Model based on 5 years of GADS data	Probabilistic Model based on 5 years of GADS data	Transition Rates representing the Equivalent Forced Outage Rates (EFORd) during demand periods over the most recent five-year period (20142015-20182019)
Energy Limited Resources (ELR)	ELR not modeled with any duration limitation	Based upon elections made by August 1 st , 2020	Existing elections are made by August 1st and will be incorporated into the model.

(1) Generating Unit Capacities

The capacity rating for each thermal generating unit is based on its Dependable Maximum Net Capability (DMNC). The source of DMNC ratings are seasonal tests required by procedures in the NYISO Installed Capacity Manual. Additionally, each generating resource has an associated capacity CRIS (Capacity Resource Interconnection Service) value. When the associated CRIS value is less than the DMNC rating, the CRIS value is modeled.

Wind units are rated at the lower of their CRIS value or their nameplate value in the model. The [2019-2020](#) NYCA Load and Capacity Report, issued by the NYISO, is the source of those generating units and their ratings included on the capacity model.

(2) Planned Generator Units

[Hudson Ave. GT 3 returning from IIFO with a capacity of 16 MW.](#) There ~~was one~~ unit reporting ~~an~~ increased rating ~~of 56.6 MW~~ for the ~~2020-2021~~ IRM study.

(3) Wind Modeling

Wind generators are modeled as hourly load modifiers using hourly production data over the period ~~2014-2015-2018-2019~~. Each calendar production year represents an hourly wind shape for each wind facility from which the GE MARS program will randomly select. New units will use the zonal hourly averages of current units within the same zone. ~~Characteristics of this data indicate a capacity factor of approximately 16.3% during the summer peak hours.~~ As shown in table A.7, a total of 1,8~~65.7~~ MW of installed capacity associated with wind generators.

Table A.7 Wind Generation

B1 - Wind Resources				
Wind Resource	Zone	CRIS (MW)	Summer Capability (MW)	Summer MARS Model (MW)
Active Wind Units				
Bliss Wind Power	A	100.5	100.5	100.5
Canandaigua Wind Power	C	125.0	125.0	125.0
High Sheldon Wind Farm	C	112.5	118.1	112.5
Howard Wind	C	57.4	55.4	55.4
Orangeville Wind Farm	C	94.4	93.9	93.9
Wethersfield Wind Power	C	126.0	126.0	126.0
Altona Wind Power	D	97.5	97.5	97.5
Chateaugay Wind Power	D	106.5	106.5	106.5
Clinton Wind Power	D	100.5	100.5	100.5
Ellenburg Wind Power	D	81.0	81.0	81.0
Jericho Rise Wind Farm	D	77.7	77.7	77.7
Marble River Wind	D	215.2	215.2	215.2
Hardscrabble Wind	E	74.0	74.0	74.0
Madison Wind Power	E	11.5	11.6	11.5
Maple Ridge Wind	E	231.0	231.0	231.0
Maple Ridge Wind	E	90.7	90.8	90.7
Munnsville Wind Power	E	34.5	34.5	34.5
		1735.9	1739.2	1733.4
Proposed Wind Units				
Cassadaga Wind	A	126.0	126.5	126.0
		126.0	126.5	126.0
Total Wind Resources				
	A	226.5	227.0	226.5
	B	0.0	0.0	0.0
	C	515.3	518.4	512.8
	D	678.4	678.4	678.4
	E	441.7	441.9	441.7
		1861.9	1865.7	1859.4

(4) Solar Modeling

Solar generators are modeled as hourly load modifiers using hourly production data over the period [20142015-20182019](#). Each calendar production year represents an hourly solar shape for each solar facility which the GE MARS program will randomly select from. A total of [5431.5](#) MW of solar capacity was modeled in Zone K.

(5) Retirements/Deactivations/ ICAP Ineligible

There are ~~two-three~~ units totaling ~~837-1104~~ MW MW ~~that~~ have become deactivated. ~~Forced Outages~~In addition, units totaling 188.2 MW have been removed from the 2021 IRM study because they did not participate in the ICAP market.

Performance data for thermal generating units in the model includes forced and partial outages, which are modeled by inputting a multi-state outage model that is representative of the “equivalent demand forced outage rate” (EFORd) for each unit represented. Generation owners provide outage data to the NYISO using Generating Availability Data System (GADS) data in accordance with the NYISO Installed Capacity Manual. The NYSRC is continuing to use a five-year historical period for the ~~2020-2021~~ IRM Study.

Figure A.4 shows a rolling 5-year average of the same data.

Figures A.5 and A.6 show the availability trends of the NYCA broken out by fuel type.

The multi-state model for each unit is derived from five years of historic events if it is available. For units with less than five years of historic events, the available years of event data for the unit is used if it appears to be reasonable. For the remaining years, the unit NERC class-average data is used.

The unit forced outage states for the most of the NYCA units were obtained from the five-year NERC GADS outage data collected by the NYISO for the years 2014 through 2018. This hourly data represents the availability of the units for all hours. From this, full and partial outage states and the frequency of occurrence were calculated and put in the required format for input to the GE-MARS program.

Figures A.6 and A.7 show the unit availabilities of the entire NERC fleet on an annual and 5-year historical basis.

Figure A.4 Five-Year Zonal EFORDs

Commented [A2]: Figures A.4-A.8 need to be updated

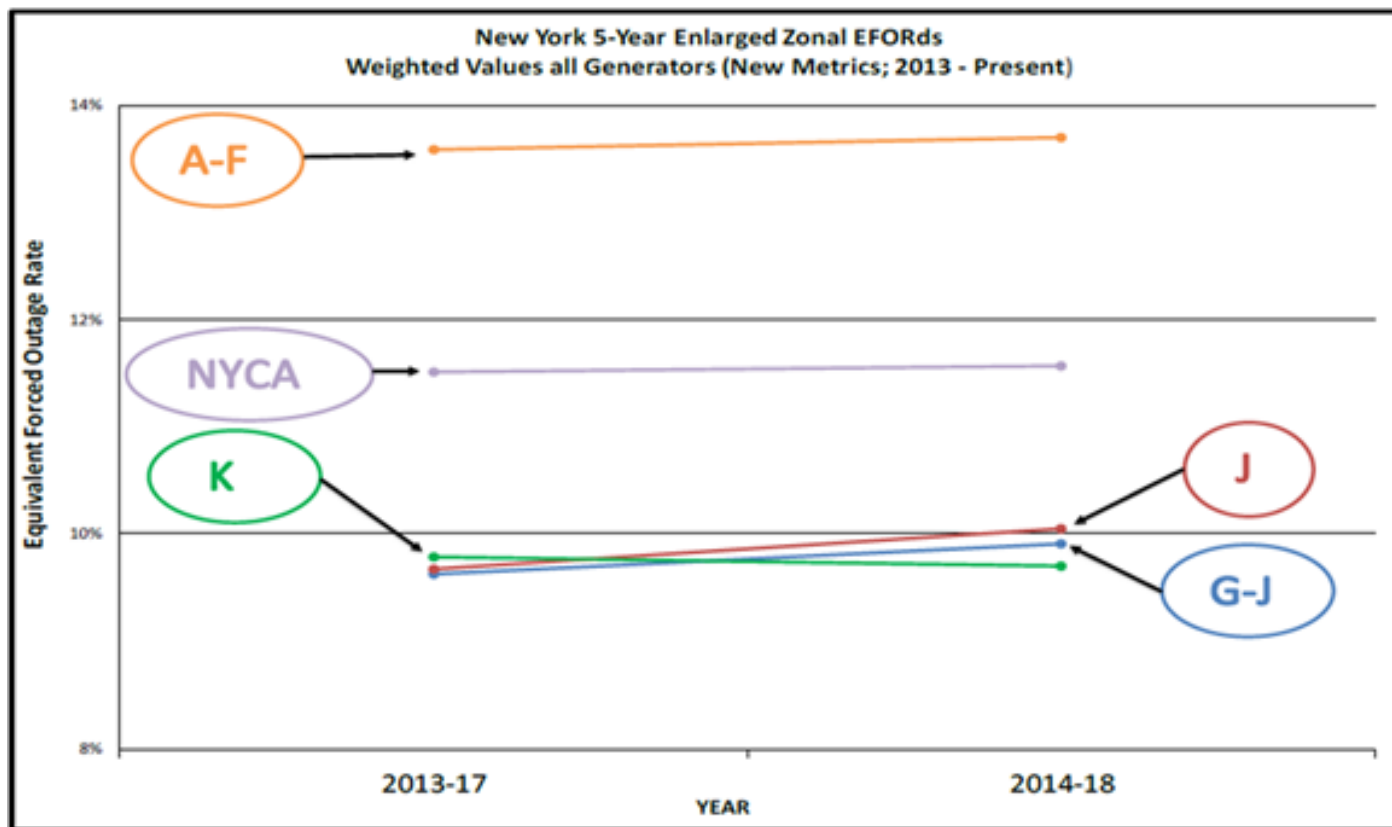

Figure A.5 NYCA Annual Availability by Fuel

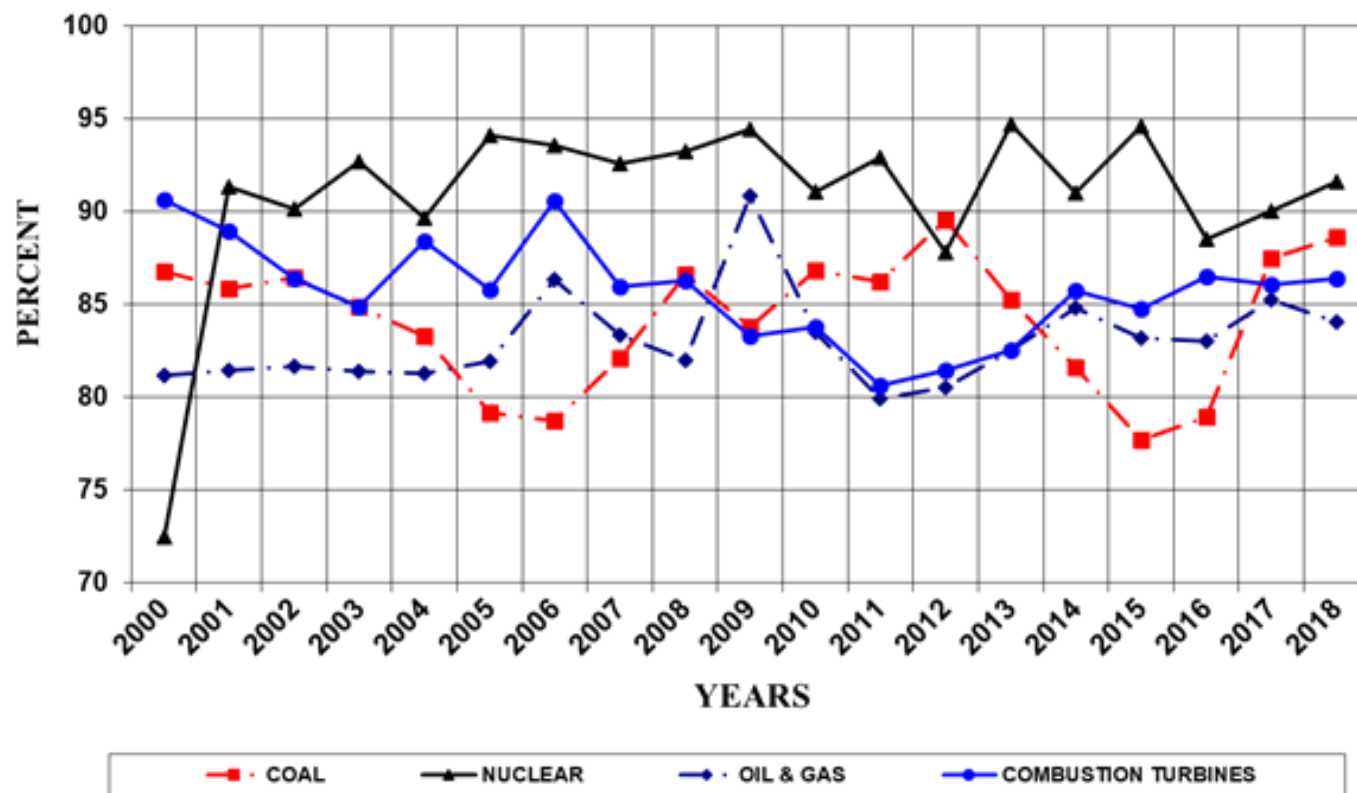

Figure A.6 NYCA Five-Year Availability by Fuel

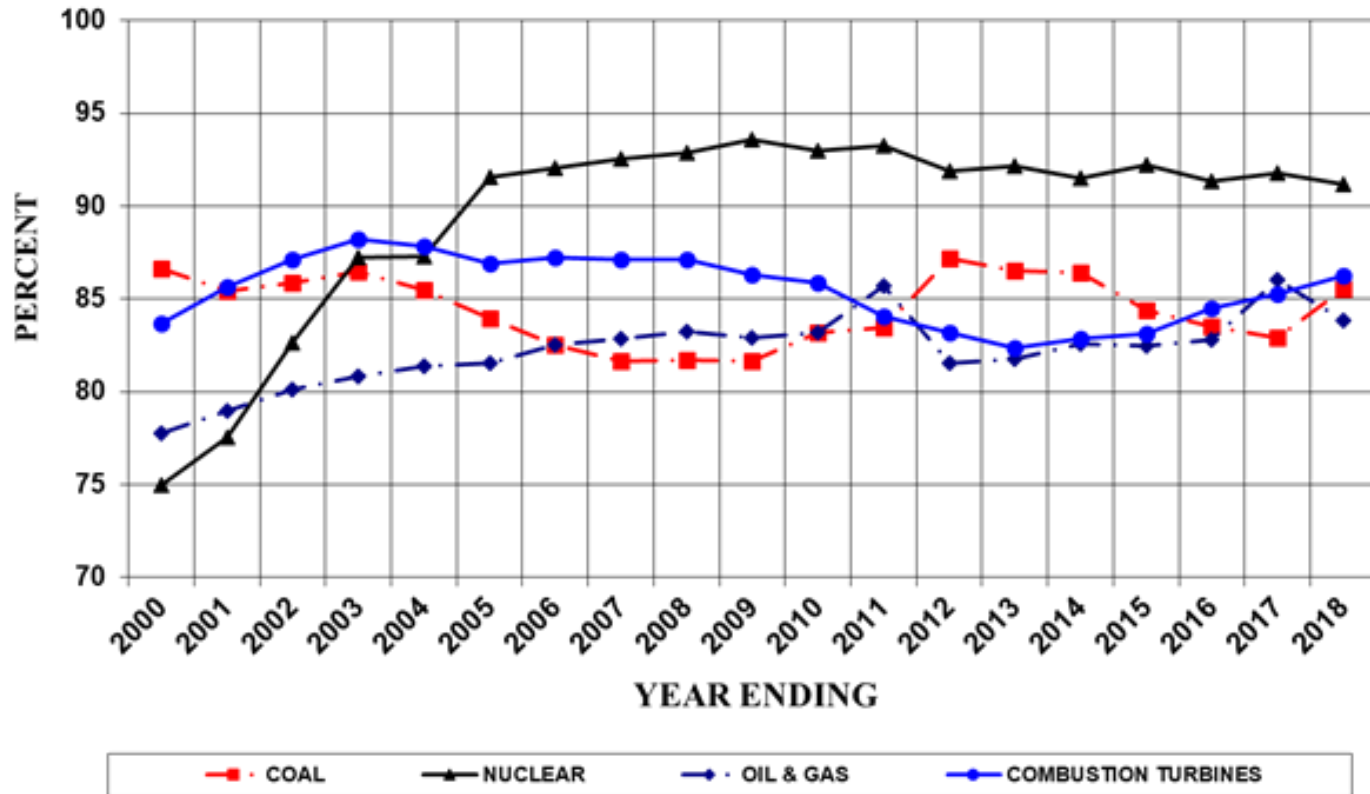

Figure A.7 NERC Annual Availability by Fuel

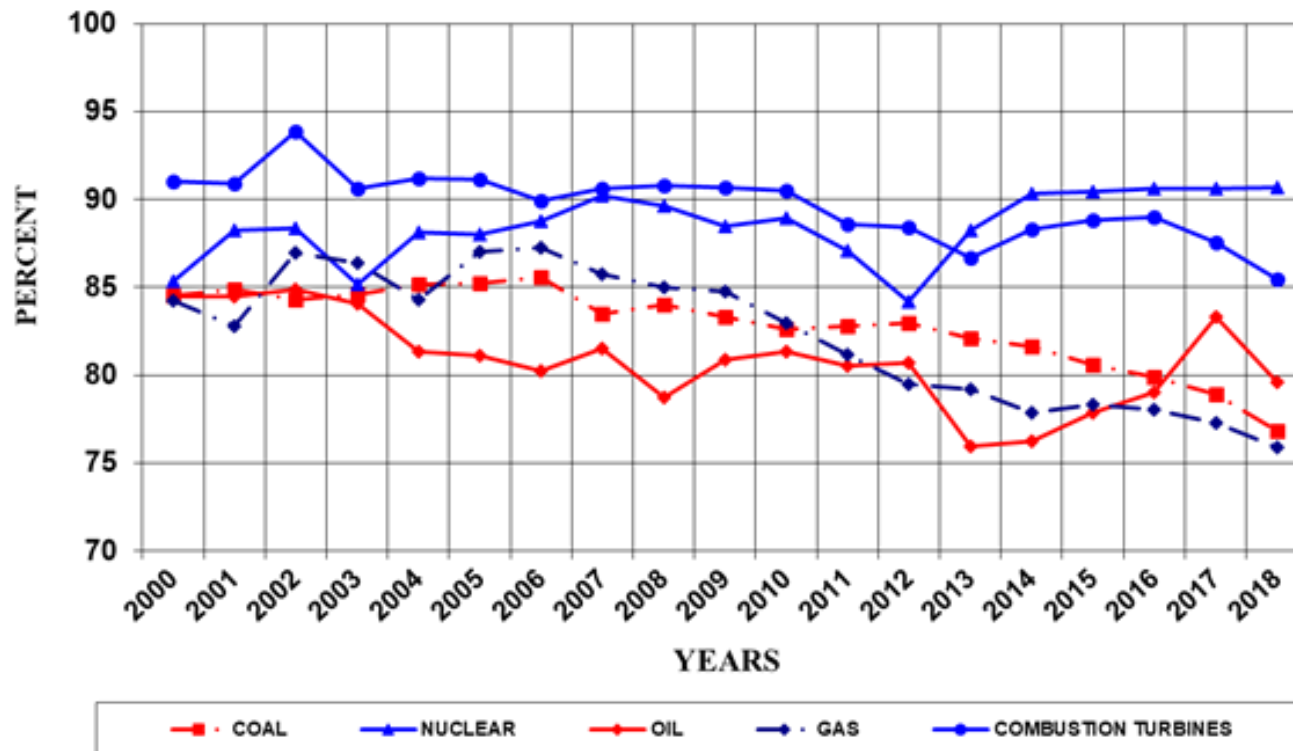
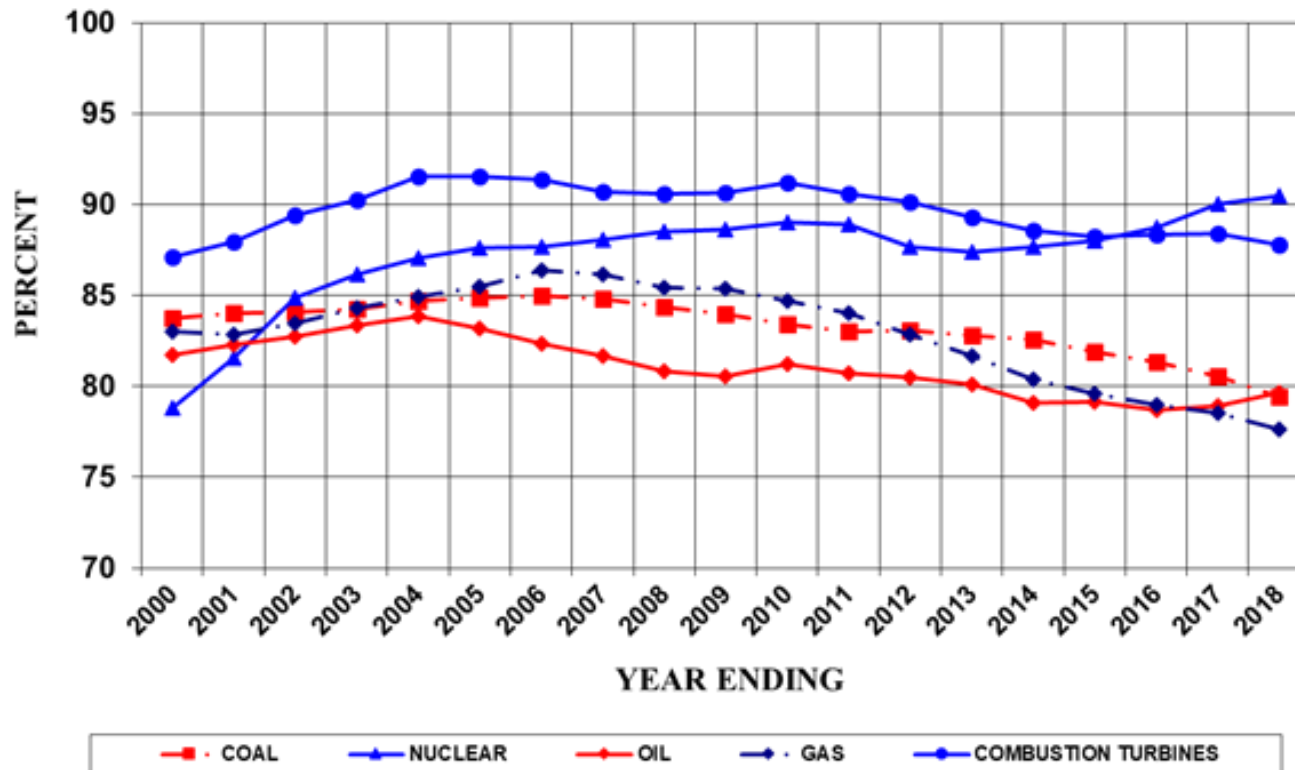

Figure A.8 NERC Five-Year Availability by Fuel



(6) Outages and Summer Maintenance

A second performance parameter to be modeled for each unit is scheduled maintenance. This parameter includes both planned and maintenance outage components. The planned outage (PO) component is obtained from the generator owners. When this information is not available, the unit's historic average planned outage duration is used. Figure A.9 provides a graph of scheduled outage trends over the 2003 through [2018-2019](#) period for the NYCA generators.

Typically, generator owners do not schedule maintenance during the summer peak period. However, it is highly probable that some units will need to schedule maintenance during this period. Each year, the previous summer capability period is reviewed to determine the scheduled maintenance MW during the previous peak period. An assumption is determined as to how much to model in the current study. For the [2020-2021](#) IRM Study, a nominal 50 MW of summer maintenance is modeled. The amount is nominally divided equally between Zone J and Zone K. Figure A.10 shows the weekly scheduled maintenance for the [2019-2020](#) IRM Study compared to this study.

(7) Gas Turbine Ambient De-rate

Operation of combustion turbine units at temperatures above DMNC test temperature results in reduction in output. These reductions in gas turbine and combined cycle capacity output are captured in the GE-MARS model using de-ratings based on ambient temperature correction curves. Based on its review of historical data, the NYISO staff has concluded that the existing combined cycle temperature correction curves are still valid and appropriate. These temperature correction curves, provided by the Market Monitoring Unit of the NYISO, show unit output versus ambient temperature conditions over a range starting at 60 degrees F to over 100 degrees F. Because generating units are required to report their DMNC output at peak or "design" conditions (an average of temperatures

obtained at the time of the transmission district previous four like capability period load peaks), the temperature correction for the combustion turbine units is derived for and applied to temperatures above transmission district peak loads.

(8) Large Hydro De-rates

Hydroelectric projects are modeled as are thermal units, with a probability capacity model based on five years of unit performance. See Capacity Models item 6 above.

Figure A.9 Planned and Maintenance Outage Rates

Commented [A3]: Needs Updating

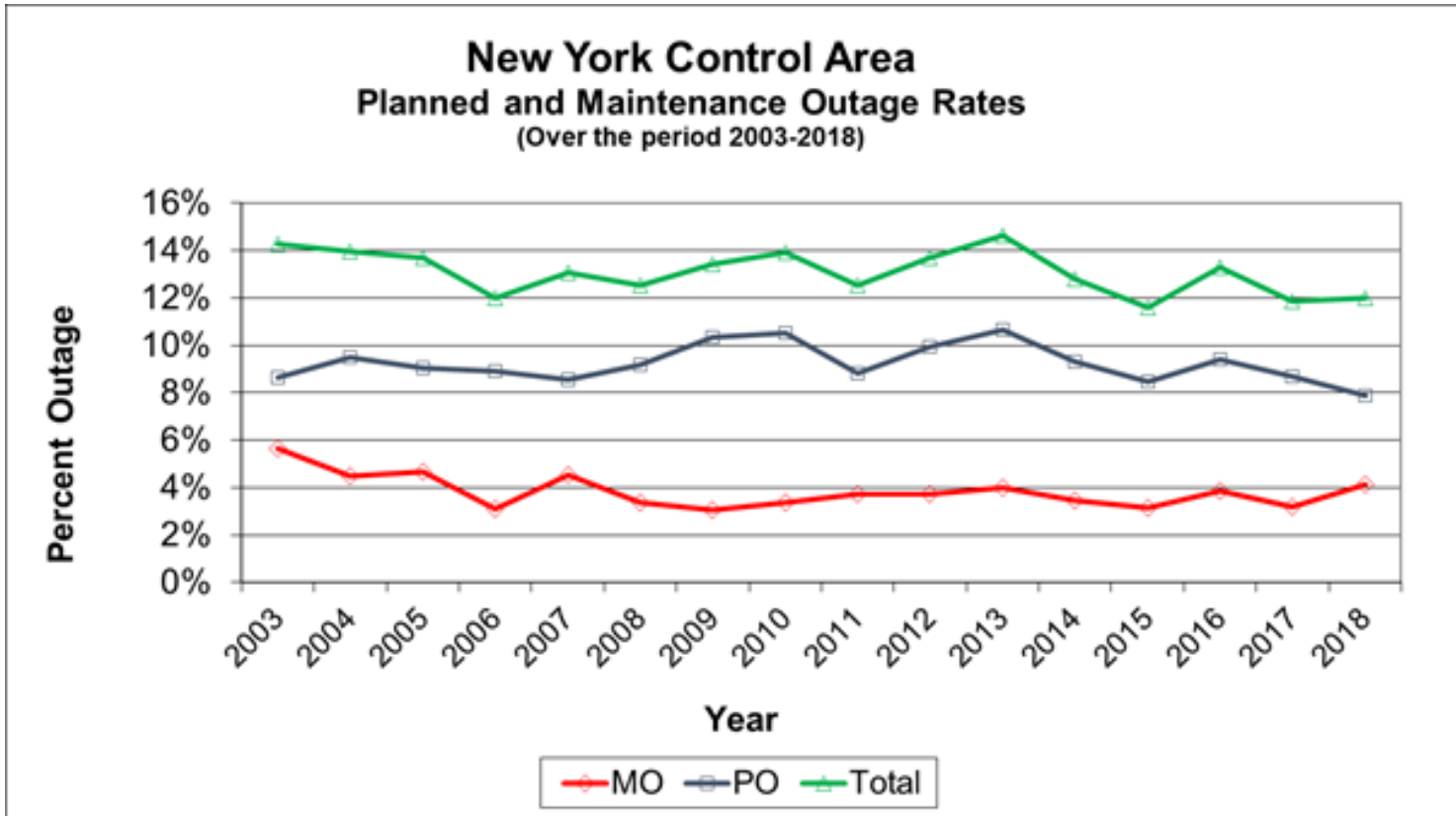
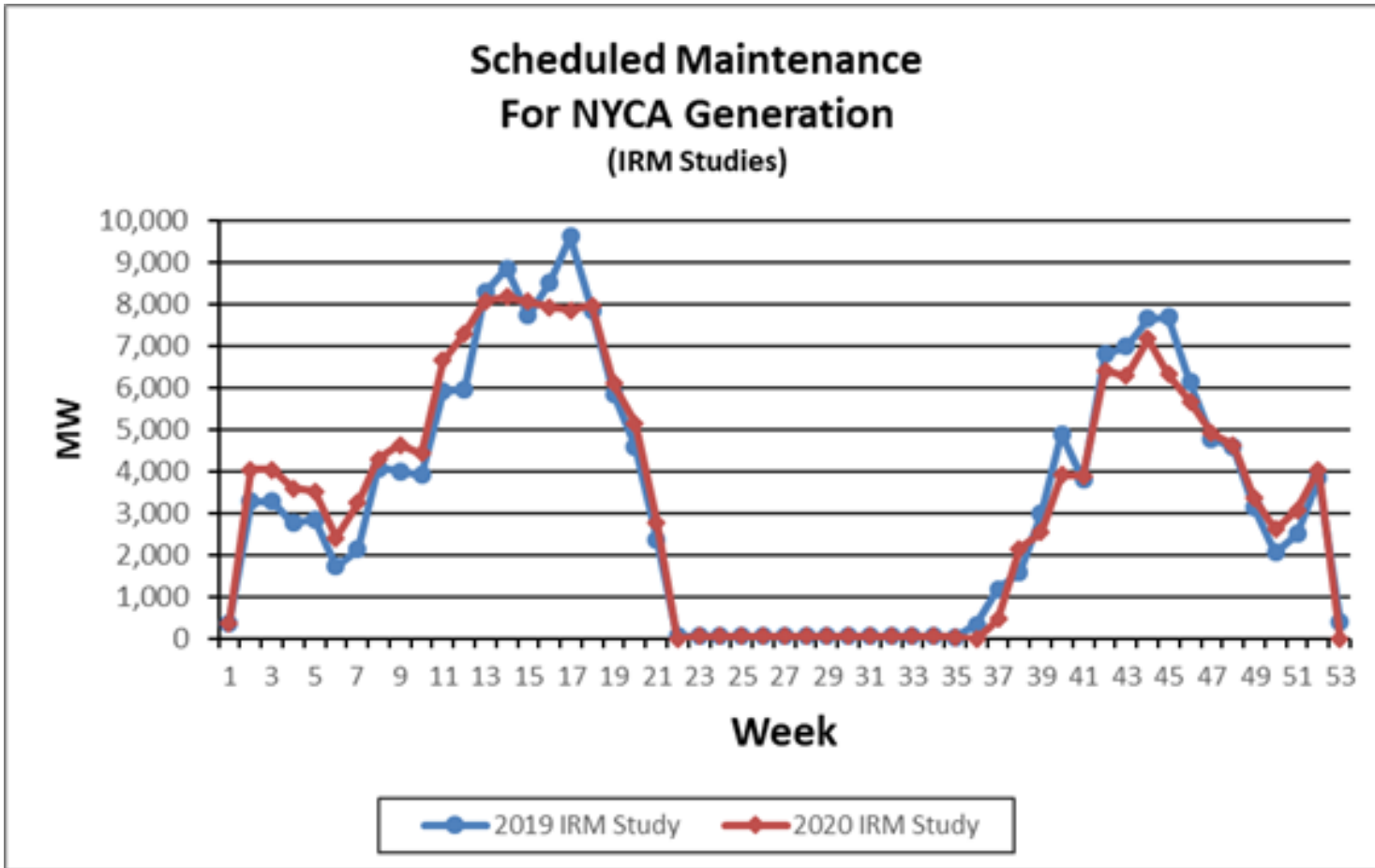

Figure A.10 Scheduled Maintenance

Commented [A4]: Needs Updating



A.3.3 Transmission System Model

A detailed transmission system model is represented in the GE-MARS topology. The transmission system topology, which includes eleven NYCA Zones and four External Control Areas, along with transfer limits, is shown in Figure A.11. The transfer limits employed for the 2020 IRM Study were developed from emergency transfer limit analyses included in various studies performed by the NYISO and based upon input from Transmission Owners and neighboring regions. A list of those studies is shown in Table A.8, below. The transfer limits are further refined by other assessments conducted by the NYISO. The assumptions for the transmission model included in the 2020 IRM Study are listed in Table A.8, which reflects changes from last year's model. The changes that are captured in this year's model are: 1) an update to the UPNY-SENY Interface Group; 2) an update to the Jamaica Ties (from Zone J to Zone K) and; 3) an update to the UPNY-ConEd Interface (from Zone G to Zone H); 4) the Cedars bubble merged into the HQ bubble. The 2020 topology changes are primarily driven by addition of the Cricket Valley Energy Center, and deactivation of the Indian Point 2 nuclear unit.

Forced transmission outages are included in the GE-MARS model for the underground cables that connect New York City and Long Island to surrounding Zones. The GE-MARS model uses transition rates between operating states for each interface, which were calculated based on the probability of occurrence from the historic failure rates and the time to repair. Transition rates into the different operating states for each interface were calculated based on the circuits comprising each interface, including failure rates and repair times for the individual cables, and for any transformer and/or phase angle regulator

Commented [A5]: Needs updating

associated with that cable. The TOs provided updated transition rates for their associated cable interfaces.

Table A.8 Transmission System Model

Parameter	2019 Model Assumptions	2020 Model Assumptions Recommended	Basis for Recommendation
UPNY-SENY Interface Group	Single interface group with a fixed limit of 5500 MW	Dual interface groups consisting of one group with a fixed limit of 5600 MW and the other group with a dynamic limit up to 6950 MW	Addition of the Cricket Valley Energy Center (1020 MW CRIS in Zone G) and the Leeds-Hurley Avenue SDU (series compensation) to be in service prior to Summer 2020.
Jamaica Ties (from J to K)	235 MW of tie capability from Zone J to Zone K, and 1528 MW limit on a grouped interface from Zones I and J to Zone K	320 MW of tie capability from Zone J to Zone K, and 1593 MW limit on a grouped interface from Zones I and J into Zone K	Addition of Rainey-Corona 345/138 kV PAR in service based on PSEG-LI's input and consistent with 2019-2018 CRP updates
UPNY-ConEd Interface (from G to H)	5750 MW interface limit from Zone G to Zone H	6000 MW interface limit from Zone G to Zone H	Scheduled retirement of Indian Point 2 nuclear unit in year 2020
The Cedars bubble merged into the HQ bubble	1500 MW limit of summer rating from HQ to Zone D, and a separate Cedars bubble with an interface summer rating of 190 MW to Zone D	1690 MW limit of summer rating from HQ to Zone D (Cedars bubble removed)	The HQ Cedars upgrade project requires MARS areas of HQ and Cedars to be combined and modeled as a single area.

Transmission Lines B and C	0 MW combined on the two ties with a 105 MW grouped interface limit on the A, B, and C lines into Zone J	No change from 2019 model assumption	An estimate of tie capability reduction due to the extended outage of those lines.
Line 33 From Ontario to Zone D	150 MW of tie capability in both directions 1,750 MW limit on a grouped interface leaving Ontario with a 1,500 MW limit entering Ontario	No change from 2019 model assumption	An estimate of tie capability reduction due to the extended outage of the PAR affecting that interface.
VFT and HTP return lines	Return lines avoid cutting across the PJM-SENY grouped interface	No change from 2019 model assumption	These return paths could affect the total transfer capability if cutting across the grouped interface.
Interface Limits (other than those identified above)	All changes reviewed and commented on by TPAS	No change from 2019 model assumption	Based on the most recent NYISO studies and processes, such as Operating Study, Operations Engineering Voltage Studies, Comprehensive System Planning Process, and additional analysis including interregional planning initiatives.
Cable Forced Outage Rates	All existing Cable EFORS updated for NYC and LI to reflect most recent five-year history	All existing Cable EFORS updated for NYC and LI to reflect most recent five-year history	Based on TO analysis or NYISO analysis where applicable
UDR line Unavailability	Five-year history of forced outages	Five-year history of forced outages	NYISO/TO review

Figure A.11 shows the transmission system representation for this year's study. Figure A.12 shows the dynamic limits used in the topology.

Figure A.11 2020 IRM Topology

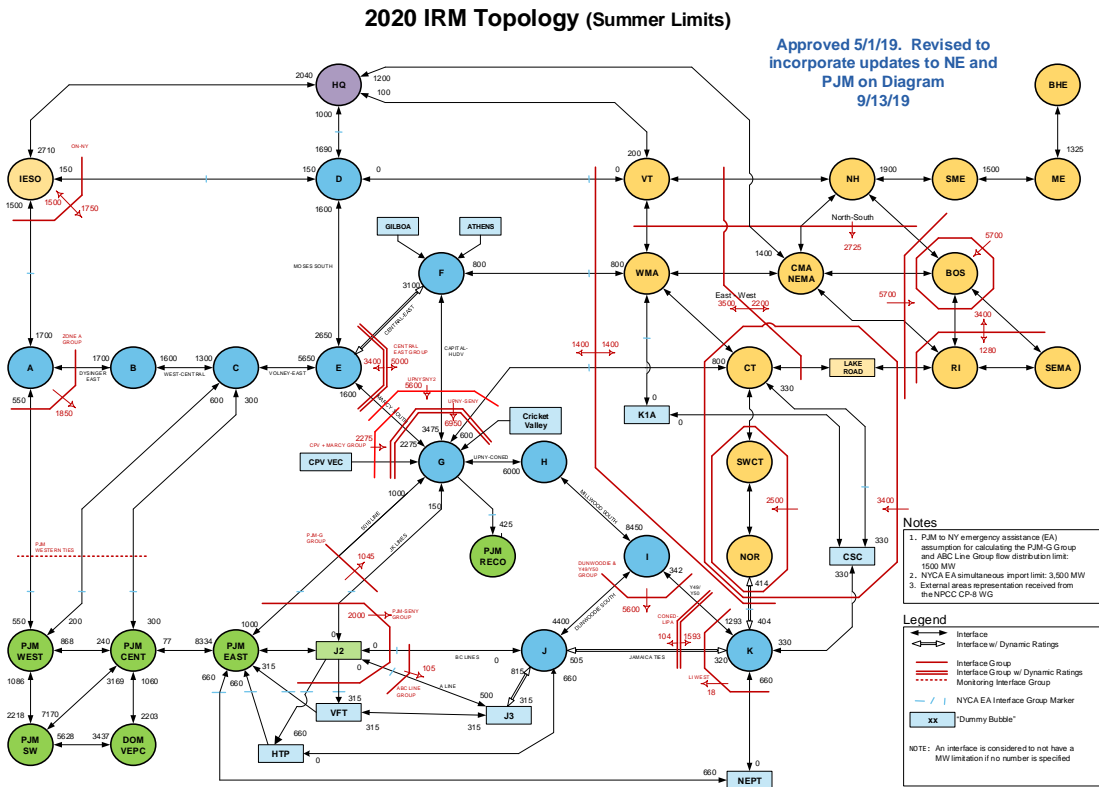

Figure A.12 Dynamic Interface Ratings Information

2020 MARS Topology - Dynamic Limits and Grouping Information

September 26, 2019

Interface Group	Limit	Flow Equation
UPNY-SENY	Dynamic	$(F_to_G) + (E_to_G) - (HUDV_NE) + (CPV\ to\ G) + (CVEC\ to\ G)$
UPNYSNY2	5600	$(F_to_G) + (E_to_G) - (HUDV_NE)$
E2G_CPV	2275	$(E_to_G) + 0.9*(CPV\ to\ G)$
LI_WEST	18	$(K\ to\ I\&J) - 0.13*(K_NEPT)$

UPNY-SENY Dynamic Limit (MW)*	Units Available		
	CPV	Cricket	Athens
6,950	2	3	3
6,750	2	3	2
6,700	1	3	3
6,550	2	2	3
6,150	2	1	3
5,950	1	1	3
5,800	2	0	3
6,600	All Other Conditions		

Central East Voltage Limits, Oswego Complex Units

Depends On:	9MILP1, 9MILP2, FPNUC1, STHIND, OS05, OS06			
Units Available	E_to_F		E_to_FG	
	Fwd	Rev	Fwd	Rev
6	3,100	1,999	5,000	3,400
5	3,050	1,999	4,925	3,400
4	2,990	1,999	4,840	3,400
3	2,885	1,999	4,685	3,400
2	2,770	1,999	4,510	3,400
Otherwise:	2,645	1,999	4,310	3,400

Staten Island Import Limits, AK and Linden CoGen Units

Unit Availability				J_to_J3	
AK02	AK03	LINCOG1	LINCOG2	Fwd	Rev
A	A	A	A	315	200
U	A	A	A	315	500
A	U	A	A	315	700
A	A	U	A	315	500
A	A	A	U	315	500
Otherwise:				315	815

Long Island Import Limits, Northport

Depends On:	NPRTG1, NPRTS1-4	
Units Available	LI_NE	
	Norwalk to K	K to Norwalk
5	260	414
Otherwise:	404	414

Long Island Import Limits, Barret Steam Units

Depends On:	BARS01, BARS02			
Units Available	Jamaica Ties		ConEd-LIPA	
	J to K	K to J	IJ to K	K to IJ
2	320	505	1,593	104
1	320	390	1,593	74
0	320	236	1,593	0

As can be seen in Table A.9, the following changes were made to NYCA interface limits:

Table A.9 Interface Limits Updates

Interface	2019		2020		Delta	
	Forward	Reverse	Forward	Reverse	Forward	Reverse
UPNY-SENY Interface Group	UPNY-SENY: 5500	-	UPNY-SENY: 6950/6750/6700/ 6550/6150/5950/ 5800/6600 UPNYSNY2: 5600	-	UPNY-SENY: 1450/1250/1200 /1050/650/450/ 300/1100 UPNYSNY2: 100	-
Jamaica Ties	235	505/390/ 236	320	505/390/ 236	85	0/0/0
Y49Y50 + Jamaica Ties	1528	104/74/0	1593	104/74/0	65	0/0/0
UPNY-ConEd Interface	5750	-	6000	-	250	-
HQ to Zone D	1500	1000	1690	1000	190	0
Cedars to Zone D	190	-	Cedars bubble removed		-	-

The topology for the 2020 IRM Study features four changes from the topology used in the 2019 IRM Study.

1. Update to the UPNY-SENY Interface Group

The Cricket Valley Energy Center (1020 MW CRIS in Zone G) and the Leeds-Hurley Avenue SDU (static synchronous series compensator) have been scheduled to be in service prior to Summer 2020. These changes will influence the UPNY-SENY interface group. The addition of Leeds-Hurley Avenue SDU project alone will increase the interface group limit from 5500 MW to 5600 MW. The impact of adding Cricket Valley Energy Center units is represented in the model by an additional dynamic interface group with a nomogram limit up to 6950 MW depending on the status of Cricket Valley, CPV Valley, and Athens units.

2. Update to the Jamaica Ties

The new Rainey-Corona 345/138 kV PAR has been in service during Summer 2019. Based on PSEG-LI's input and consistent with 2019-2028 Comprehensive Reliability Plan (CRP) updates, the emergency limit from Zone J to Zone K (Jamaica Ties) will increase from 235 MW to 320 MW. As a result, the grouped interface limit from Zones I and J into Zone K (Y49Y50 plus Jamaica Ties) will increase from 1528 MW to 1593 MW accordingly.

3. Update to the UPNY-ConEd Interface

The Indian Point 2 nuclear unit is going to retire in year 2020. The UPNY-ConEd interface will be impacted by this retirement. Based on 2018 Reliability Need Assessment (RNA) study scenario of retiring both Indian Point units, the NYISO calculated the emergency limit of UPNY-ConEd interface from Zone G to Zone H to be 6000 MW associated with retiring only Indian Point 2 nuclear unit, which will be an increase of 250 MW from current limit of 5750 MW.

4. The Cedars bubble merged into the HQ bubble

Although the HQ Cedars upgrade project of 80 MW external deliverability right (EDR) will not be completed until year 2021, the upgrade will require MARS areas of HQ and Cedars to be combined and modeled as a single area. As a result, the Cedars bubble along with its tie to Zone D (summer rating of 190 MW) are removed from the topology, while the limit of summer rating from the HQ bubble to Zone D is increased from 1500 MW to 1690 MW.

Additional topology changes were made to the external area models in accordance with information received through NPCC's CP-8 working group.

A.3.4 External Area Representations

NYCA reliability largely depends on emergency assistance from its interconnected Control Area neighbors (New England, Ontario, Quebec and PJM) based on reserve sharing agreements with these external Control Areas. Load and capacity models of these Areas are therefore represented in the GE-MARS analyses with data received directly from the Areas and through NPCC sources.

The primary consideration for developing the final load and capacity models for the external Control Areas is to avoid over-dependence on the external Control Areas for emergency capacity support.

For this reason, a limit is placed on the amount of emergency capacity support that the NYISO can receive from external Control Areas in the IRM study. The 3,500 MW value of this limit for this IRM study is based on a recommendation from the ICS and the NYISO that considers the amount of ten-minute reserves that are available in the external Control Areas above an Area's required reserve, along with other factors.

In addition, an external Control Area's LOLE assumed in the IRM Study cannot be lower than its LOLE criteria and its Reserve Margin can be no higher than its minimum requirement. If the Area's reserve margin is lower than its requirement and its LOLE is higher than its criterion, pre-emergency Demand Response can be represented. In

other words, the neighboring Areas are assumed to be equally or less reliable than NYCA.

Another consideration for developing models for the external Control Areas is to recognize internal transmission constraints within the external Control Areas that may limit emergency assistance to the NYCA. This recognition is considered implicitly for those Areas that have not supplied internal transmission constraint data. Additionally, EOPs are removed from the external Control Area models.

Finally, the top three summer peak load days of an external Control Area should be specified in the load model to be coincident with the NYCA top three peak load days. The purpose of this is to capture the higher likelihood that there will be considerably less load diversity between the NYCA and external Control Areas on very hot summer days.

For this study, both New England and PJM continue to be represented as multi-area models, based on data provided by these Control Areas. Ontario and Quebec are represented as single area models. The load forecast uncertainty model for the outside world model was supplied from the external Control Areas.

Modeling of the neighboring Control Areas in the base case in accordance with Policy 5-10 is as follows:

Table A.10 External Area Representations

Commented [A6]: Needs updating

Parameter	2020 Study Assumption	2021 Study Assumption	Explanation
Capacity Purchases	Grandfathered amounts: PJM – 1080 MW HQ – 1110 MW All contracts model as equivalent contracts	Grandfathered amounts: PJM – 1080 MW HQ – 1110 MW All contracts model as equivalent contracts	Grandfathered Rights, ETCNL, and other FERC identified rights.
Capacity Sales	Long term firm sales of <u>281.1</u> MW	Long term firm sales of <u>265.9</u> MW	These are long term federally monitored contracts.
External Area Modeling	Single Area representations for Ontario and Quebec. Five areas modeled for PJM. Thirteen zones modeled for New England	Single Area representations for Ontario and Quebec. Five areas modeled for PJM. Thirteen zones modeled for New England	The load and capacity data are provided by the neighboring Areas. This updated data may then be adjusted as described in Policy 5
Reserve Sharing	All NPCC Control Areas have indicated that they will share reserves equally	All NPCC Control Areas have indicated that they will share reserves equally	Per NPCC CP-8 working group assumption.

Table A.11 shows the final reserve margins and LOLEs for the Control Areas external to NYCA. The [2021](#) external area model was updated from [2020](#) but still includes a 3,500 MW limit for emergency assistance (EA) imports during any given hour. As per Table 7-1 of the IRM study report, the difference in between the isolated case and the final base case was [6.9%](#) in [2021](#) VS. [7.5%](#) in [2020](#).

Table A.11 Outside World Reserve Margins

Commented [A7]: Needs updating

Area	2019 Study Reserve Margin	2020 Study Reserve Margin	2019 Study LOLE (Days/Year)	2020 Study LOLE (Days/Year)
Quebec	44.1%*	38.7%*	0.110	0.105
Ontario	34.0%**	18.1%	0.104	0.108
PJM	16.1%	15.9%	0.149	0.226
New England	13.8%	13.1%	0.119	0.112

*This is the summer margin.

**This includes 4,347 MW full capacity of wind units.

A.3.5 Emergency Operating Procedures (EOPs)

There are many steps that the system operator can take in an emergency to avoid disconnecting load. EOP steps 2 through 10 listed in Table A.13 were provided by the NYISO based on operator experience. Table A.12 lists the assumptions modeled.

The values in Table A.13 are based on a NYISO forecast that incorporates [2020](#) (summer) operating results. This forecast is applied against a [2021](#) peak load forecast of [32,243](#) MW. The table shows the most likely order that these steps will be initiated. The actual order will depend on the type of the emergency. The amount of assistance that is provided by EOPs related to load, such as voltage reduction, will vary with the load level.

Table A.12 Assumptions for Emergency Operating Procedures

Parameter	2020 Study Assumption	2021 Study Assumption	Explanation
Special Case Resources*	July 2019 –1,282 MW based on registrations and modeled as 873 MW of effective capacity. Monthly variation based on historical experience*	July 2020 –1195 MW based on registrations and modeled as 822 MW of effective capacity. Monthly variation based on historical experience	SCRs sold for the program discounted to historic availability. Summer values calculated from July 2020 registrations. Performance calculation updated per ICS presentations on SCR performance.
Other EOPs	692 MW of non-SCR/non-EDRP resources	844.4 MW of on-SCR/non-EDRP resources	Based on TO information, measured data, and NYISO forecasts.
EOP Structure	12 EOP Steps Modeled	10 EOP Steps Modeled	Based on agreement with ICS, step 1 and 2 separated, step 3 removed

- The number of SCR calls is limited to [15 per year](#) when calculating LOLE.

Table A.13 Emergency Operating Procedures Values

Step	Procedure	2020 MW Value	2021 MW Value
1	Special Case Resources –Load, Gen	1,282 MW Enrolled/ 873 MW modeled	1,195 MW Enrolled/ 822 MW modeled
2	5% manual voltage Reduction	57 MW	59.64 MW
3	Thirty-minute reserve to zero	655 MW	655 MW
4	5% remote voltage reduction	347 MW	445.42 MW
5	Voluntary industrial curtailment	207 MW	259.36 MW
6	General Public Appeals	80 MW	80 MW
7	Emergency Purchases	Varies	Varies
8	Ten-minute reserves to zero	1,310 MW	1,310 MW
9	Customer disconnections	As needed	As needed
10	Adjustment used if IRM is lower than technical study margin	As needed	As needed

A.3.6 Locational Capacity Requirements

The GE-MARS model used in the IRM study provides an assessment of the adequacy of the NYCA transmission system to deliver assistance from one Zone to another for meeting load requirements. Previous studies have identified transmission constraints into certain Zones that could impact the LOLE of these Zones, as well as the statewide LOLE. To minimize these potential LOLE impacts, these Zones require a minimum portion of their NYCA ICAP requirement, *i.e.*, locational ICAP, which shall be electrically located within the Zone to ensure that enough energy and capacity are available in that Zone and that NYSRC Reliability Rules are met. For the purposes of the IRM study, Locational ICAP requirements are applicable to two transmission-constrained Zones, New York City and Long Island, and are normally expressed as a percentage of each Zone’s annual peak load.

These locational ICAP requirements, recognized by NYSRC Reliability Rule A.2 and monitored by the NYISO, supplement the statewide IRM requirement. This report using the unified methodology determines the minimum locational requirements for different levels of installed reserve. The NYSRC chooses the IRM to be used for the coming year and the NYISO chooses the final value of the locational requirements to be met by the LSEs.

A.3.7 Special Case Resources and Emergency Demand Response Program

Special Case Resources (SCRs) are loads capable of being interrupted, and distributed generators, rated at 100 kW or higher, that are not directly telemetered. SCRs are ICAP resources that only provide energy/load curtailment when activated in accordance with the NYISO Emergency Operating Manual. Performance factors for SCRs are shown in Table A.14:

Table A.14 SCR Performance

SCR Performance for 2021 IRM Study						
Super Zones	Enrollments (July 2020)	Forecast (2021) ¹	Performance Factor ²	UCAP (2021)	Adjustment Factor ³	Model Value
A-F	622.8	622.8	0.862	537.2	0.949	509.5
G-I	102.0	102.0	0.747	76.2	0.851	64.9
J	427.3	427.3	0.693	296.2	0.752	222.7
K	43.0	43.0	0.706	30.3	0.821	24.9
Totals	1195.1	1195.1		940.0		822.1
					Overall Performance = 68.8%	

Table A.14 note 1: These values represent no growth from July 2020 ICAP based enrollments. Table A.14 note 2: The Performance Factor is based on the ACL methodology. Table A.14 note 3: The SCR Adjustment factor (3) captures two different performance derates; 1) Calculated Translation Factor (TF) between ACL and CBL values, and the Fatigue Factor (FF=1.00)

~~The Emergency Demand Response Program (EDRP) is a separate program that allows registered interruptible loads and standby generators to participate on a voluntary basis and be paid for their ability to restore operating reserves.~~

GE-MARS model accounts for SCRs ~~and EDRP~~ as a EOP steps and will activate ~~these~~ ~~this~~ steps to minimize the probability of customer load disconnection. Both GE-MARS and NYISO operations only activate EOPs in zones where they are capable of being delivered.

SCRs are modeled with monthly values. For the month of July, the registered value is 1195.1 MW. The effective value of ~~903-822.1~~ MW is used in the model.

~~EDRPs are modeled as a 1 MW EOP step in July and August (and they are also further discounted in other months) with a limit of five calls per month. This EOP is discounted from the forecast registered amount of 5.5 MW based on actual experience.~~

A.4 MARS Data Scrub

A.4.1 GE Data Scrub

General Electric (GE) was asked to review the input data for errors. GE has developed a program called “Data Scrub” which processes the input files and flags data that appears to be out of the ordinary. For example, it can identify a unit with a forced outage rate significantly higher than all the others in that size and type category. If something is found, the NYISO reviews the data and either confirms that it is the right value as is or institutes an update. The results of this data scrub are shown in Table A.15 for the preliminary base case.

Commented [A8]: Needs updating

Table A.15 GE MARS Data Scrub

Item	Description	Disposition	Data Change	Post PBC* Affect
1	Name changes for two units were identified between the 2019 and 2020 study	Both name changes were reviewed and accepted	No	N/A
2	Retirement dates for two units have changed	Retirement dates were verified	No	N/A
3	Two units changed their classification type	These units changed their fuel source	No	N/A
4	Unit added, but with retirement date before study start date	Retirement date typo corrected before PBC	Yes	N/A
5	A single unit last year was modeled as two smaller units	Units modeled as presented through data submissions	No	N/A
6	Nine units identified with large EFORD change	These units, part of a larger annual review, were confirmed to be correct	No	N/A
7	Six units identified with large EFORD change	One unit retired and the other five went through a second review and were found correct in the model	No	N/A
8	Energy, even though not an explicit IRM assumption, appears higher in the model, for the base study year, than gold book forecast	A known effect of growing historical load shapes to meet future peaks. Initiative underway to study alternatives.	No	N/A
9	Internal PJM and NE interface ratings different on Drawing	Ratings were updated in MIF but not on drawing. They have been updated now.	No	N/A

*Preliminary Base Case

A.4.2 NYISO Data Scrub

The NYISO also performs a review of the MARS data independently from GE. Table A.16 shows the results of this review for the preliminary base case.

Table A.16 NYISO MARS Data Scrub

Item	Description	Disposition	Data Change	Post PBC* Affect
1	Study Year Change causes unreasonable result	We did not change study year per GE suggestion and ICS approval	N	0
2	G1 to G interface install date was beyond start date of study	Corrected for the PBC case	N	0
3	NE Capacity for spring was incorrect	Corrected for the PBC case	N	0
4	Scheduled maintenance appeared incorrectly in a shoulder month	Corrected for the PBC case	N	0
5	Energy Storage unit was counted as 25 MW instead of correct value of 5 MW	The correction to 5 MW reduced the availability by 20 MW in the PBC and is now reflected in the final base case	Y	0.1%
6	Greenidge Capability value was not updated for the PBC	Greenidge value updated from 104.3 to 104.0 MW	Y	~0.0%
7	Greenidge load value was not updated for the PBC	Greenidge BTM-NG load value updated from 11.6 to 10.2 MW	Y	~0.0%
8	EFORd value for CPV and Cricket Valley needs updating in calculation spreadsheet	MIF is correct. Update to spreadsheet resulted in no impact to LOLE. (3 MW in spreadsheet for IRM)	Y	~0.0%

*Preliminary Base Case

A.4.3 Transmission Owner Data Scrub

In addition to the above reviews, two transmission owners scrub the data and assumptions from a masked database provided. All their findings reiterated the previous findings. Table A.17 shows their unique results.

Table A.17 Transmission Owner Data Scrub

Item	Description	Disposition	Data Change	Post PBC* Affect
1	PJM internal ties all differ in mif from those on the diagram	Diagram has now been updated	N	0
2	CT-IMPEX interface grouping definition incorrect	Corrections made. Grouping was used for monitor purpose only and does not impact results.	Y	0
3	NE North to South rating in MIF is different than the diagram	Diagram has now been updated	N	0
Other:				

Item	Description	Disposition	Data Change	Post PBC* Affect
4	ICS member suggested that the random selection of intermittent shapes should be aligned for each iteration	This issue will be discussed and studied for the 2021 IRM study	N	0

*Preliminary Base Case

Appendix B

Details of Study Results

B. Details for Study Results

B.1 Sensitivity Results

Table B.1 summarizes the 2020-2021 Capability Year IRM requirements under a range of assumption changes from those used for the base case. The base case utilized the computer simulation, reliability model, and assumptions described in Appendix A. The sensitivity cases determined the extent of how the base case required IRM would change for assumption modifications, either one at a time, or in combination. The methodology used to conduct the sensitivity cases was to start with the preliminary base case 18.6% IRM results then add or remove capacity from all zones in NYCA until the NYCA LOLE approached criterion. The values in Table B.1 page 47 are the sensitivity results adjusted to the 18.9% final base case except as noted.

Commented [A9]: NYISO to update

B.2 Impact of Environmental Regulations

Commented [A10]: NYISO to provide update

Federal, state and local government regulatory programs may impact the operation and reliability of New York's bulk power system. Compliance with state and federal regulatory initiatives and permitting requirements may require investment by the owners of New York's existing thermal power plants to continue in operation. If the owners of those plants must make considerable investments, the cost of these investments could impact whether and in what manner they remain available in the NYISO's markets and therefore potentially affect the reliability of the bulk power system. Other regulatory initiatives being undertaken by the State of New York will preclude certain units from continuing in operation in their current configuration. Prior studies have identified the amounts of capacity that may be negatively impacted by new and developing regulations. Most recently, New York has enacted the Climate Leadership and Community Protection Act (CLCPA) and promulgated various regulations collectively intended to limit Greenhouse Gas (GHG) emissions and support the development of new renewable energy and energy storage resources and deployment of energy efficiency measures. This section reviews the status of various regulatory programs.

B.2.1 Combustion Turbine NOx Emission Limits

The New York State Department of Environmental Conservation (DEC) has proposed Part 227-3 which will significantly lower NOx emission limits for simple cycle gas turbines. The proposed rule will require compliance actions for units with approximately 3,300 MW of capacity (nameplate) located predominantly in southeastern New York. The proposed rule requires the owners of the affected facilities to file compliance plans by March 2020. The proposed rule will be applicable during the ozone season (OS) (May 1- September 30) and establishes lower emission limits in two phases, effective May 1, 2023 and May 1, 2025. A review of emission reports shows that approximately one third of the units have demonstrated emission rates that can achieve the initial set of lower limits. The proposed rule also provides for emission averaging plans where the output of the affected facility can be averaged on a daily basis with the output of near-by storage resources or new renewable energy resources under common control. The rule provides for the continued operation of facilities necessary for compliance with reliability standards for a period of up to two years with the possibility of another two-year period.

B.2.2 U.S. Clean Water Act: Best Technology Available for Plant Cooling Water Intake

The U.S. Environmental Protection Agency (EPA) has issued a new Clear Water Act Section 316b rule providing standards for the design and operation of power plant cooling systems. This rule is being implemented by the DEC, which has finalized a policy for the implementation of the Best Technology Available (BTA) for plant cooling water intake structures. This policy is activated upon renewal of a plant's water withdrawal and discharge permit. Based upon a review of current information available from the DEC, the NYISO has estimated that 15,500 MW of nameplate capacity is affected by this rule, some of which could be required to undertake major system retrofits, including closed-cycle cooling systems.

Indian Point Energy Center had been involved in an extended renewal of its State Pollution Discharge Elimination System (SPDES) Permit. The resolution of that process is the planned retirement of Unit #2 on April 30, 2020 and Unit #3 on April 30, 2021.

Plant	Status as of October 2019
Arthur Kill	BTA in place, verification under review
Astoria	BTA in place, verification under review
Barrett	Permit drafting underway with equipment enhancements, SAPA extended
Bowline	BTA in place, 15% Capacity Factor, verification under review
Brooklyn Navy Yard	BTA Decision pending
Cayuga	BTA in place
Danskammer	BTA in place
East River	BTA in place
Fitzpatrick	BTA studies being evaluated
Ginna	BTA studies being evaluated
Greenidge	BTA Decision made, installing upgrades, studies being evaluated
Indian Point	BTA in place, limit operations
Nine Mile Pt 1	BTA studies being evaluated
Northport	BTA in place, verification under review
Oswego	Leaning towards Capacity Factor limitation
Port Jefferson	BTA in place, 15% Capacity Factor, verification, SAPA extended
Ravenswood	BTA in place, verification under review
Roseton	BTA in place, studies being evaluated
Somerset	BTA equipment upgrades identified

B.2.3 Part 251: Carbon Dioxide Emissions Limits

The DEC promulgated a rule establishing an emission limit for CO₂ for existing fossil-fueled generating units. Approximately 700 MW of remaining coal-fired generation capacity in New York State is expected to exit the market through 2020. New York's coal-fired generation accounted for less than 1% of the total energy produced in the

state in 2018. Upon receipt of deactivation notices from the generators, the NYISO's planning processes will assess whether such deactivations trigger potential reliability needs.

B.2.4 New York City Residual Oil Elimination

New York City passed legislation in December 2017 that will prohibit the combustion of fuel oil Numbers 6 and 4 in electric generators within New York City by 2020 and 2025, respectively. The rule applies to about 3,000 MW of generation in New York City. Affected generators have filed compliance plans with NYC agencies to switch to Number 2 fuel oil. The affected generators are developing new fuel storage and handling equipment necessary to convert their facilities to comply with the law.

B.2.5 Regional Greenhouse Gas Initiative (RGGI)

RGGI is a multi-state carbon dioxide emissions cap-and-trade initiative that requires affected generators to procure emissions allowances enabling them to emit carbon dioxide. Through a program review, the RGGI states agreed to several program changes, including a 30% cap reduction between 2020 and 2030, essentially ratcheting down the availability of allowances to generators that emit greenhouse gases. The proposed emission allowance caps are not likely to trigger reliability concerns as the program design provides for mechanisms which consider reliability on various timescales, including multi-year compliance periods, allowance banking provisions, the Cost Containment Reserve, and periodic program reviews. New Jersey has rejoined RGGI and will participate with its first carbon dioxide cap in 2020 since withdrawing from the program in 2011. The Governor of Pennsylvania has issued an executive order directing PA DEP to prepare draft rules for limiting CO₂ emissions from power plants with methods that would allow for the trading of allowances with RGGI.

B.2.6 Distributed Generator NOx Emission Limits

The DEC has proposed, Part 222, a rule to limit the NOx emissions from small behind the meter generators that operate as an economic dispatch source in the New York City Metropolitan Area located at facilities with NOx emissions less than 25 NOx tons per year and are driven by reciprocating or rotary internal combustion engines. The proposed emission limits will become effective in two phases, May 1, 2020 and May 1, 2025. The facility must have either obtain a registration or permit by March 15, 2020 and must notify NYSDEC whether the generator will operate as an economic dispatch source such that the provisions of Part 222 apply. The first emission limitations can be achieved by engines manufactured subsequent to 2000 and some subset of older engines.

B.2.7 Cross State Air Pollution Rule (CSAPR)

The CSAPR limits emission of SO₂ and NO_x from fossil fuel-fired EGUs >25 MW in 27 eastern states by establishing new caps and limited allowance trading programs. If the statewide trading limit is exceeded emissions above the limit require additional penalty allowances. NYCA OS NO_x emissions are highly sensitive to the continued operation of the NYCA nuclear generation fleet. 2018 OS NO_x emissions were reportedly 4,842 tons across NY; 6% below the 5,135 ton budget. The CSAPR OS occurs May 1-September 30.

B.2.1 Climate Leadership and Community Protection Act (CLCPA)

The CLCPA requires, among other things, that 70% of electric energy be generated from renewable resources by 2030 and 100% of electric energy be provided by zero emission resources by 2040. The statute will require the displacement of NYCA's fossil-fueled generating fleet with renewable resources. During this transition, the NPCC and NYSRC resource adequacy rules will require the NYCA to maintain resource adequacy for the New York bulk electric system. In addition, the Greenhouse Gas ("GHG") emission reduction requirements will likely necessitate electrification of the building space and water heating and transportation sectors as an approach to reduce economy-wide emissions. The act builds upon programs and targets already established by the Clean Energy Standard (CES) and in other state policies. The combined set of requirements for new resources follow:

Year	New York State Policy Mandate
2025	6,000 MW Distributed PV 185 Tbtu Energy Efficiency of which 30,000 GWH is attributable to the electricity sector 1,500 MW Energy Storage Resources
2029	Expiration of the Zero Emission Credit Program
2030	3,000 MW Energy Storage Resources 2,400 Off Shore Wind Resources 70% of NY electricity from renewable resources 40% reduction in New York State's GHG emissions compared to 1990
2035	9,000 MW Off Shore Wind Resources
2040	Zero Emissions from the electric power sector
2050	85-100% reduction in New York State's GHG emissions compared to 1990

B.2.2 Clean Energy Standard

In August 2016, the New York State Public Service Commission (PSC) adopted a Clean Energy Standard (CES), requiring that 50% of the electrical energy consumed in New York State be generated from renewable resources by 2030 (50x30 goal). Under the CES, electric utilities and others serving load in New York State are responsible for securing a defined percentage of the load they serve from eligible renewable and nuclear resources. The load serving entities will comply with the CES by either procuring qualifying credits or making alternative compliance payments.

In order to achieve the 50x30 goal, the PSC determined that approximately 70,500 GWh of total renewable energy will need to be generated by 2030 – including approximately 29,200 GWh of new renewable energy production in addition to existing levels of production in the 2014 baseline. Currently, the New York State Energy Research and Development Authority (NYSERDA) is offering long-term (20 year) contracts for Renewable Energy Credits (RECs) associated with eligible renewable resources and administers the procurement of Zero-Emissions Credits (ZECs) associated with the generation from eligible nuclear plants. The NYSPSC'S CES will evolve as directed by the CLCPA to incorporate the additional mandates outlined above. Notably the CLCPA target of 70x30 adjusts the definition of eligible renewable energy resources relative to the CES 50x30 goal.

B.2.3 Offshore Wind Development

The CLCPA contains a mandate for 9,000 MW of Offshore Wind (OSW) capacity to be developed by 2035. Previously, the New York PSC issued an order providing that NYSEDA, with the involvement of the Long Island Power Authority (LIPA) and the New York Power Authority (NYPA) will procure OSW RECs (ORECs) from developers for up to 2,400 MW of offshore wind. NYSEDA has announced winners of the inaugural 2018 OREC solicitation for an initial procurement of two OSW projects totaling nearly 1,700 MW.

B.2.4 Comprehensive Energy Efficiency Initiative

The PSC has approved an order to accelerate energy efficiency deployment, including the 185 Tbtu buildings site-savings energy efficiency target, which was also codified in the CLCPA. A portion of the all-fuels energy savings target will come from directed utility programs to expand access to and experience with heat pumps to replace/augment existing conventional heating sources as well as increased deployment of more conventional utility energy efficiency programs.

B.2.5 Storage Deployment Target

The CLCPA contains a mandate for 3,000 MW of Energy Storage capacity to be developed by 2030. This goal builds on top of the goal to deploy 1,500 MW energy storage capacity by 2025 outlined in NYSEDA's Energy Storage Roadmap.

B.2.6 Distributed Solar Program

The CLCPA includes a mandate for 6,000 MW of distributed solar capacity by 2025, which is an expansion of the existing 3,000 MW NY-Sun program. The PSC has been charged with developing the regulatory mechanisms to ensure the incremental 3,000 MW distributed solar comes online by 2025. Currently, NYSERDA administers the NY-Sun program.

B.3 Frequency of Implementing Emergency Operating Procedures

Commented [A11]: NYISO to update

In addition to SCRs, the NYISO will implement several other types of EOPs, such as voltage reductions, as required, to avoid or minimize customer disconnections. Projected 2020 EOP capacity values are based on recent actual data and NYISO forecasts. Table B.2 below presents the expected EOP frequencies for the 2020 Capability Year assuming the 18.9% base case IRM.

Table B.2 Implementation of EOP steps

Step	EOP	Expected Implementation (Days/Year)
1	Require Load SCRs	8.2
2	Require Generator SCRs	6.0
3	Require EDRPs	5.8
4	5% manual voltage reduction	5.8
5	30-minute reserve to zero	5.6
6	5% remote controlled voltage reduction	3.4
7	Voluntary load curtailment	2.9
8	Public appeals	2.6
9	Emergency purchases	2.4
10	10-minute reserve to zero	0.3
11	Customer disconnections	0.1

Appendix C

ICAP to UCAP Translations

C. ICAP to UCAP Translation

The NYISO administers the capacity requirements to all loads in the NYCA. In 2002, the NYISO adopted the Unforced Capacity (UCAP) methodology for determining system requirements, unit ratings and market settlements. The UCAP methodology uses individual generating unit data for output and availability to determine an expected level of resources that can be considered for system planning, operation and marketing purposes. EFORD is developed from this process for each generating unit and applied to the units Dependable Maximum Net Capacity (DMNC) test value to determine the resulting level of UCAP.

Individual unit EFORD factors are taken in aggregate on both a Statewide and Locational basis and used to effectively “translate” the IRM and LCRs previously determined in the GE-MARS Analysis in terms of ICAP, into an equivalent UCAP basis.

Table C.1 summarizes historical values (since 2000) for NYCA capacity parameters including Base Case IRMs, approved IRMs, UCAP requirements, and NYISO Approved LCRs (for NYC, LI and G-J).

Table C.1 Historical NYCA Capacity Parameters

Capability Year (May - April)	Base Case IRM (%)	EC Approved IRM (%)	NYCA Equivalent UCAP Requirement (%)	NYISO Approved NYC LCR (%)	NYISO Approved LI LCR (%)	NYISO Approved G-J LCR (%)
2000	15.5	18.0		80.0	107.0	
2001	17.1	18.0		80.0	98.0	
2002	18.0	18.0		80.0	93.0	
2003	17.5	18.0		80.0	95.0	
2004	17.1	18.0	11.90	80.0	99.0	
2005	17.6	18.0	12.00	80.0	99.0	
2006	18.0	18.0	11.59	80.0	99.0	
2007	16.0	16.5	11.30	80.0	99.0	
2008	15.0	15.0	8.35	80.0	94.0	
2009	16.2	16.5	7.17	80.0	97.5	
2010	17.9	18.0	6.12	80.0	104.5	
2011	15.5	15.5	6.03	81.0	101.5	
2012	16.1	16.0	5.35	83.0	99.0	
2013	17.1	17.0	6.58	86.0	105.0	
2014	17.0	17.0	6.38	85.0	107.0	88.0
2015	17.3	17.0	7.01	83.5	103.5	90.5
2016	17.4	17.5	6.21	80.5	102.5	90.0
2017	18.1	18.0	7.04	81.5	103.5	91.5
2018	18.2	18.2	8.08	80.5	103.5	94.5
2019	16.8	17.0	6.72	82.8	104.1	92.3
2020	18.9	18.9	9.03	86.6	103.4	90.0

C.1 NYCA and NYC and LI Locational Translations

In the “Installed Capacity” section of the NYISO Web site³, NYISO Staff regularly post summer and winter Capability Period ICAP and UCAP calculations for NYCA Locational Areas and Transmission District Loads. This information has been compiled and posted since 2006.

Locational ICAP/UCAP calculations are produced for NYC, LI, G-J Locality and the entire NYCA. Exhibits C.1.1 through C.1.4 summarizes the translation of ICAP requirements to UCAP requirements for these areas. The charts and tables included in these exhibits utilize data from the summer capability periods beginning in 2006.

This data reflects the interaction and relationships between the capacity parameters used this study, including Forecast Peak Load, ICAP Requirements, De-rating Factors, UCAP Requirements, IRMs, and LCRs. Since these parameters are so inextricably linked to each other, the graphical representation also helps one more easily visualize the annual changes in capacity requirements.

C.1.1 New York Control Area ICAP to UCAP Translation

Table C.2 NYCA ICAP to UCAP Translation

Year	Forecast Peak Load (MW)	Installed Capacity Requirement (%)	Derate Factor	ICAP Requirement (MW)	UCAP Requirement (MW)	Effective UCAP (%)
2006	33,295	118.0	0.0543	39,288	37,154	111.6
2007	33,447	116.5	0.0446	38,966	37,228	111.3
2008	33,809	115.0	0.0578	38,880	36,633	108.4
2009	33,930	116.5	0.0801	39,529	36,362	107.2
2010	33,025	118.0	0.1007	38,970	35,045	106.1
2011	32,712	115.5	0.0820	37,783	34,684	106.0
2012	33,295	116.0	0.0918	38,622	35,076	105.4
2013	33,279	117.0	0.0891	38,936	35,467	106.6
2014	33,666	117.0	0.0908	39,389	35,812	106.4
2015	33,567	117.0	0.0854	39,274	35,920	107.0
2016	33,359	117.5	0.0961	39,197	35,430	106.2
2017	33,178	118.0	0.0929	39,150	35,513	107.0
2018	32,903	118.2	0.0856	38,891	35,562	108.1
2019	32,383	117.0	0.0879	37,888	34,558	106.7
2020	32,296	118.9	0.0830	38,400	35,213	109.3

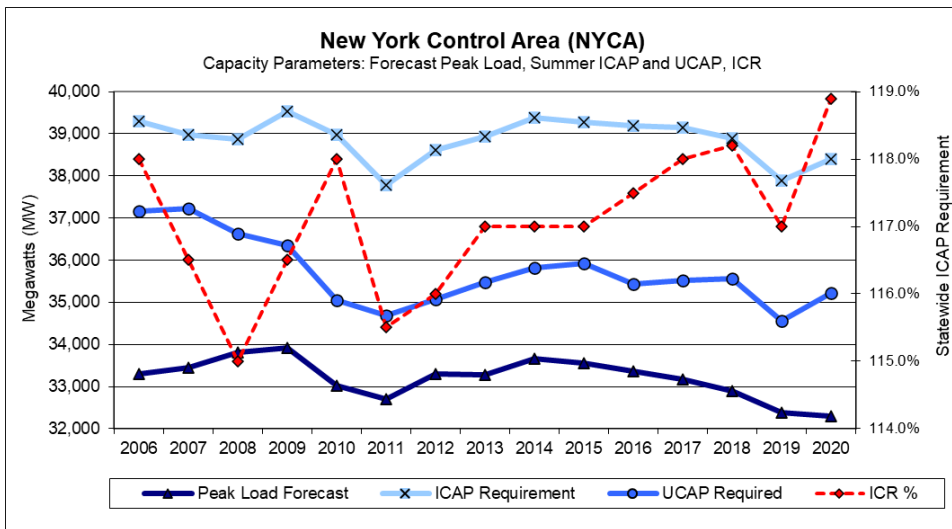

C.1.2 New York City ICAP to UCAP Translation

Table C.3 New York City ICAP to UCAP Translation

Year	Forecast Peak Load (MW)	Locational Capacity Requirement (%)	Derate Factor	ICAP Requirement (MW)	UCAP Requirement (MW)	Effective UCAP (%)
2006	11,628	80.0	0.0542	9,302	8,798	75.7
2007	11,780	80.0	0.0388	9,424	9,058	76.9
2008	11,964	80.0	0.0690	9,571	8,911	74.5
2009	12,050	80.0	0.0814	9,640	8,855	73.5
2010	11,725	80.0	0.1113	9,380	8,336	71.1
2011	11,514	81.0	0.0530	9,326	8,832	76.7
2012	11,500	83.0	0.0679	9,545	8,897	77.4
2013	11,485	86.0	0.0559	9,877	9,325	81.2
2014	11,783	85.0	0.0544	10,015	9,471	80.4
2015	11,929	83.5	0.0692	9,961	9,272	77.7
2016	11,794	80.5	0.0953	9,494	8,589	72.8
2017	11,670	81.5	0.0437	9,511	9,095	77.9
2018	11,539	80.5	0.0709	9,289	8,630	74.8
2019	11,607	82.8	0.0409	9,611	9,217	79.4
2020	11,477	86.6	0.0351	9,939	9,590	83.6

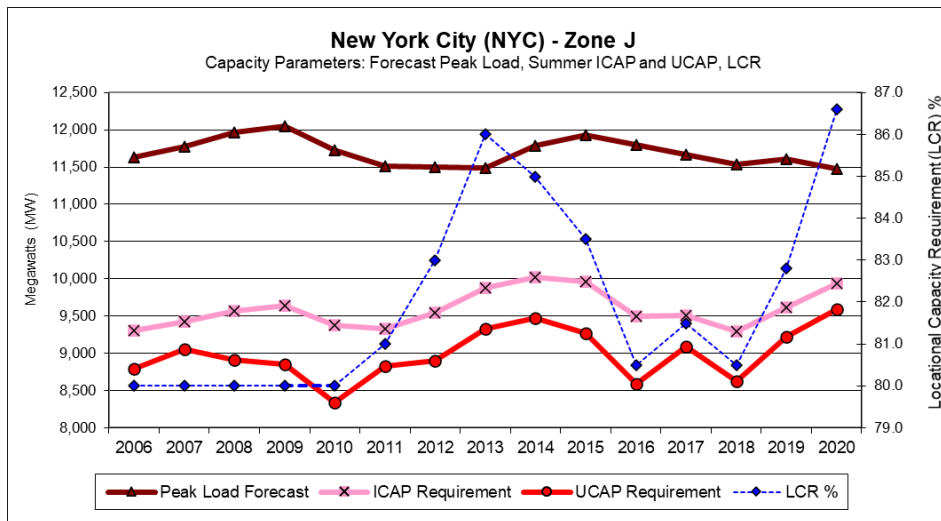

C.1.3 Long Island ICAP to UCAP Translation

Table C.4 Long Island ICAP to UCAP Translation

Year	Forecast Peak Load (MW)	Locational Capacity Requirement (%)	Derate Factor	ICAP Requirement (MW)	UCAP Requirement (MW)	Effective UCAP (%)
2006	5,348	99.0	0.0348	5,295	5,110	95.6
2007	5,422	99.0	0.0580	5,368	5,056	93.3
2008	5,424	94.0	0.0811	5,098	4,685	86.4
2009	5,474	97.5	0.1103	5,337	4,749	86.8
2010	5,368	104.5	0.1049	5,610	5,021	93.5
2011	5,434	101.5	0.0841	5,516	5,052	93.0
2012	5,526	99.0	0.0931	5,470	4,961	89.8
2013	5,515	105.0	0.0684	5,790	5,394	97.8
2014	5,496	107.0	0.0765	5,880	5,431	98.8
2015	5,539	103.5	0.0783	5,733	5,284	95.4
2016	5,479	102.5	0.0727	5,615	5,207	95.0
2017	5,427	103.5	0.0560	5,617	5,302	97.7
2018	5,376	103.5	0.0628	5,564	5,214	97.0
2019	5,240	104.1	0.0647	5,455	5,102	97.4
2020	5,228	103.4	0.0691	5,405	5,032	96.3

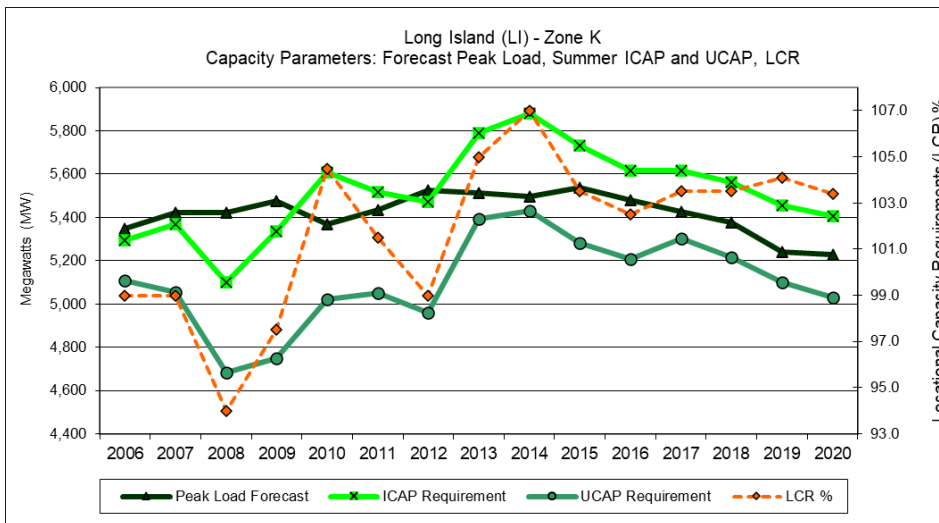

C.1.4 GHIJ ICAP to UCAP Translation

Table C.5 GHIJ ICAP to UCAP Translation

Year	Forecast Peak Load (MW)	Locational Capacity Requirement (%)	Derate Factor	ICAP Requirement (MW)	UCAP Requirement (MW)	Effective UCAP (%)
2014	16,291	88.0	0.0587	14,336	13,495	82.8
2015	16,340	90.5	0.0577	14,788	13,934	85.3
2016	16,309	90.0	0.0793	14,678	13,514	82.9
2017	16,061	91.5	0.0731	14,696	13,622	84.8
2018	15,918	94.5	0.0626	15,042	14,100	88.6
2019	15,846	92.3	0.0514	14,625	13,874	87.6
2020	15,695	90.0	0.0418	14,124	13,534	86.2

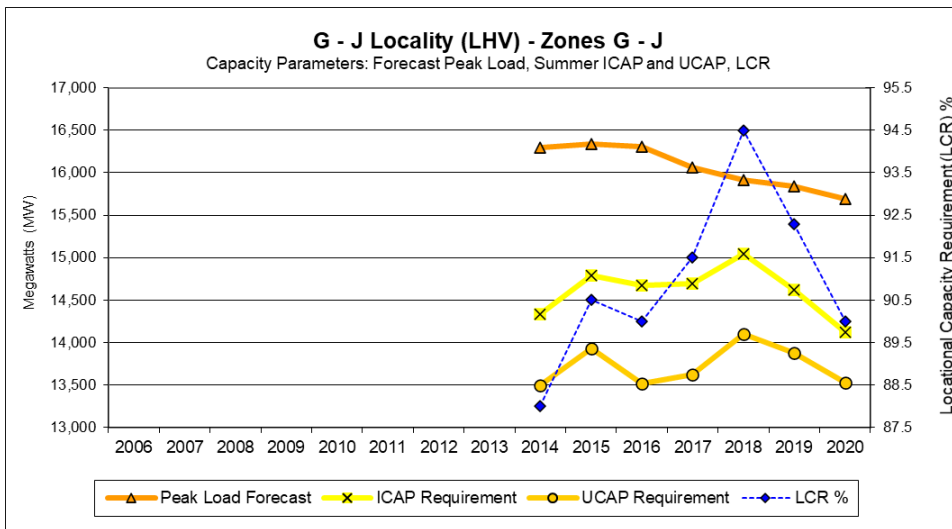

C.2 Transmission Districts ICAP to UCAP Translation

C.2.1 Central Hudson Gas & Electric

Table C.6 Central Hudson Gas & Electric ICAP to UCAP Translation

Year	Forecast Peak Load (MW)	ICAP Requirement (MW)	UCAP Requirement (MW)	% ICAP of Forecast Peak	% UCAP of Forecast Peak
2006	1,162.5	1,371.7	1,297.3	118.0%	111.6%
2007	1,205.0	1,403.8	1,341.2	116.5%	111.3%
2008	1,214.1	1,396.2	1,315.5	115.0%	108.4%
2009	1,196.3	1,393.7	1,282.1	116.5%	107.2%
2010	1,172.3	1,383.3	1,244.0	118.0%	106.1%
2011	1,176.9	1,359.3	1,247.9	115.5%	106.0%
2012	1,133.3	1,314.6	1,193.9	116.0%	105.3%
2013	1,097.5	1,284.1	1,169.7	117.0%	106.6%
2014	1,089.2	1,274.4	1,158.7	117.0%	106.4%
2015	1,083.6	1,267.8	1,159.5	117.0%	107.0%
2016	1,104.2	1,297.4	1,172.7	117.5%	106.2%
2017	1,043.1	1,230.9	1,116.5	118.0%	107.0%
2018	1,069.7	1,264.4	1,156.2	118.2%	108.1%
2019	1,090.8	1,276.3	1,164.1	117.0%	106.7%
2020	1,082.7	1,287.3	1,180.5	118.9%	109.0%

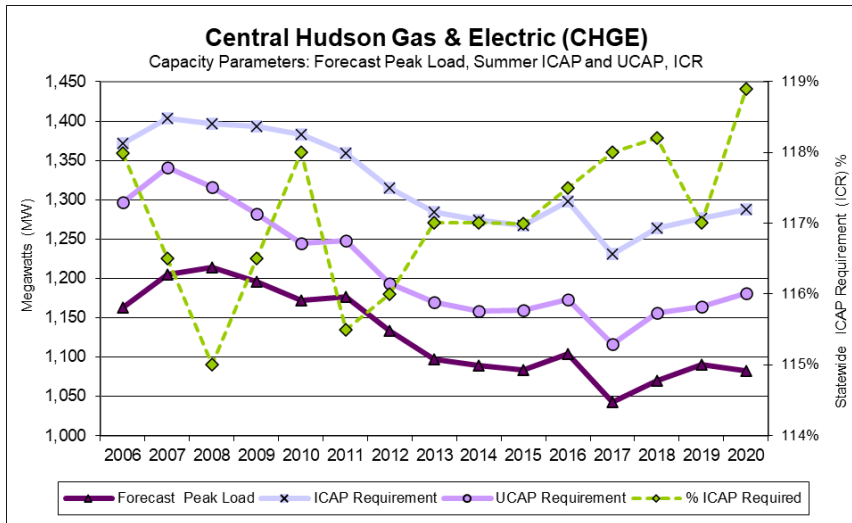

C.2.2 Consolidated Edison (Con Ed)

Table C.7 Con Ed ICAP to UCAP Translation

Year	Forecast Peak Load (MW)	ICAP Requirement (MW)	UCAP Requirement (MW)	% ICAP of Forecast Peak	% UCAP of Forecast Peak
2006	13,400.0	15,812.0	14,953.4	118.0%	111.6%
2007	13,633.6	15,883.1	15,174.7	116.5%	111.3%
2008	13,911.1	15,997.8	15,073.1	115.0%	108.4%
2009	14,043.0	16,360.1	15,049.6	116.5%	107.2%
2010	13,654.9	16,112.8	14,490.2	118.0%	106.1%
2011	13,450.5	15,535.3	14,261.4	115.5%	106.0%
2012	13,430.5	15,579.4	14,149.2	116.0%	105.4%
2013	13,370.8	15,643.8	14,250.0	117.0%	106.6%
2014	13,718.7	16,050.9	14,593.5	117.0%	106.4%
2015	13,793.0	16,137.8	14,759.6	117.0%	107.0%
2016	13,704.6	16,102.9	14,555.4	117.5%	106.2%
2017	13,534.0	15,970.1	14,486.5	118.0%	107.0%
2018	13,309.6	15,732.0	14,385.3	118.2%	108.1%
2019	13,305.5	15,567.4	14,199.1	117.0%	106.7%
2020	13,170.0	15,659.1	14,359.4	118.9%	109.0%

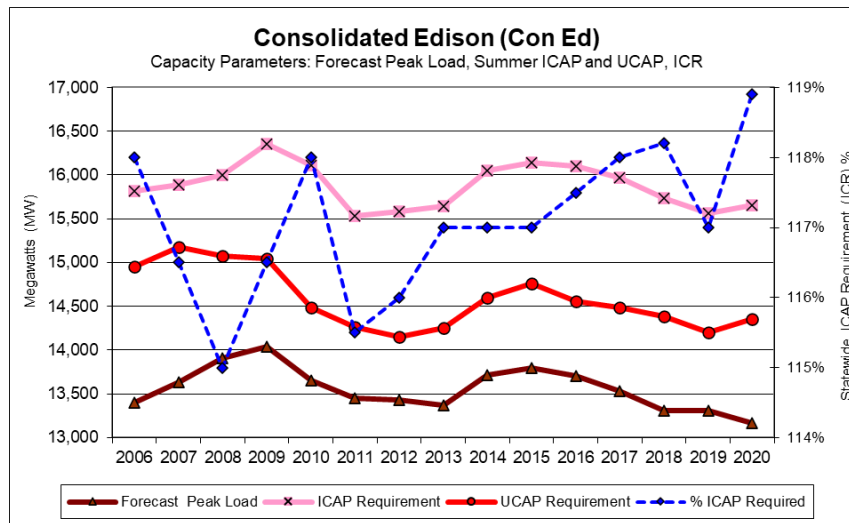

C.2.3 Long Island Power Authority (LIPA)

Table C.8 LIPA ICAP to UCAP Translation

Year	Forecast Peak Load (MW)	ICAP Requirement (MW)	UCAP Requirement (MW)	% ICAP of Forecast Peak	% UCAP of Forecast Peak
2006	5,406.2	6,379.3	6,032.9	118.0%	111.6%
2007	5,321.8	6,199.9	5,923.4	116.5%	111.3%
2008	5,358.9	6,162.7	5,806.5	115.0%	108.4%
2009	5,431.7	6,327.9	5,821.1	116.5%	107.2%
2010	5,286.0	6,237.5	5,609.4	118.0%	106.1%
2011	5,404.3	6,242.0	5,730.1	115.5%	106.0%
2012	5,508.3	6,389.6	5,803.1	116.0%	105.4%
2013	5,448.9	6,375.2	5,807.2	117.0%	106.6%
2014	5,470.1	6,400.0	5,818.9	117.0%	106.4%
2015	5,541.3	6,483.3	5,929.7	117.0%	107.0%
2016	5,491.3	6,452.3	5,832.2	117.5%	106.2%
2017	5,427.2	6,404.1	5,809.1	118.0%	107.0%
2018	5,368.1	6,345.1	5,802.0	118.2%	108.1%
2019	5,253.0	6,146.0	5,605.8	117.0%	106.7%
2020	5,172.9	6,150.6	5,640.1	118.9%	109.0%

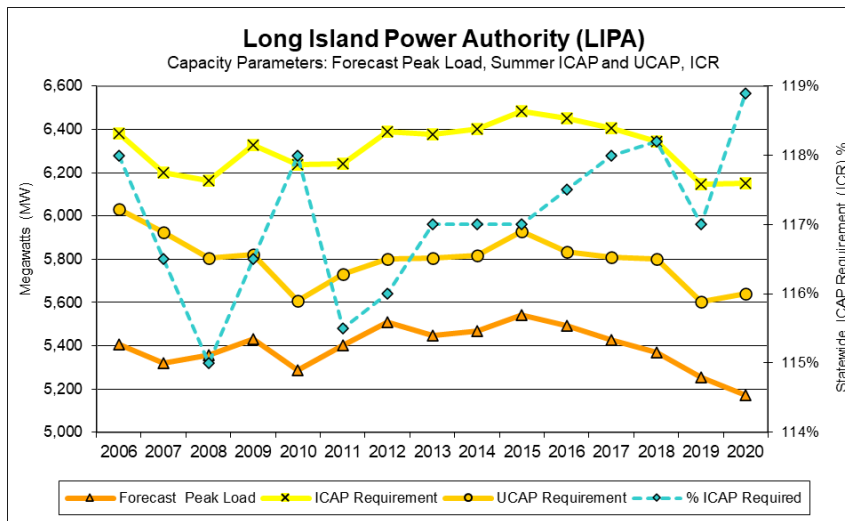

C.2.4 National Grid (NGRID)

Table C.9 NGRID ICAP to UCAP Translation

Year	Forecast Peak Load (MW)	ICAP Requirement (MW)	UCAP Requirement (MW)	% ICAP of Forecast Peak	% UCAP of Forecast Peak
2006	7,051.6	8,320.9	7,869.1	118.0%	111.6%
2007	6,718.6	7,827.2	7,478.1	116.5%	111.3%
2008	6,762.5	7,776.9	7,327.3	115.0%	108.4%
2009	6,728.4	7,838.6	7,210.7	116.5%	107.2%
2010	6,732.1	7,943.9	7,144.0	118.0%	106.1%
2011	6,574.7	7,593.8	6,971.1	115.5%	106.0%
2012	6,749.1	7,828.9	7,110.3	116.0%	105.4%
2013	6,821.3	7,980.9	7,269.8	117.0%	106.6%
2014	6,861.9	8,028.4	7,299.4	117.0%	106.4%
2015	6,880.3	8,049.9	7,362.5	117.0%	107.0%
2016	6,776.0	7,961.8	7,196.7	117.5%	106.2%
2017	6,891.4	8,131.9	7,376.4	118.0%	107.0%
2018	6,833.0	8,076.6	7,385.2	118.2%	108.1%
2019	6,608.8	7,732.3	7,052.6	117.0%	106.7%
2020	6,670.2	7,930.9	7,272.6	118.9%	109.0%

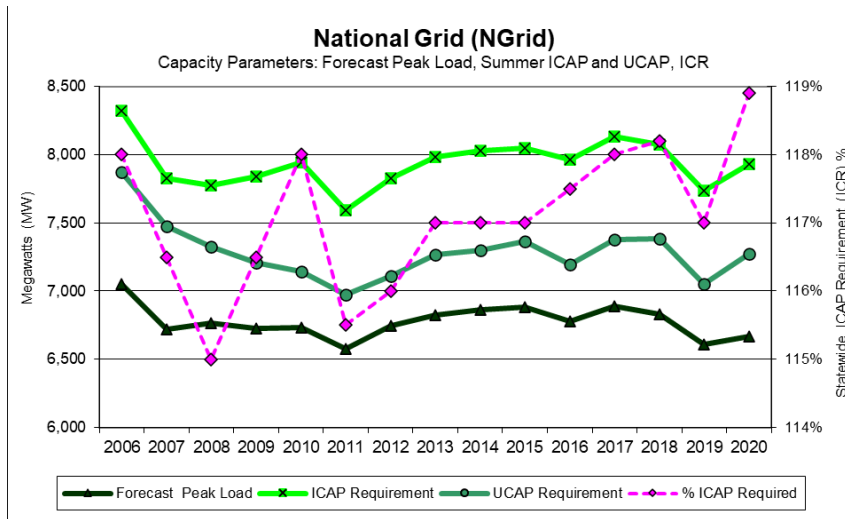

C.2.5 New York Power Authority (NYPA)

Table C.10 NYPA ICAP to UCAP Translation

Year	Forecast Peak Load (MW)	ICAP Requirement (MW)	UCAP Requirement (MW)	% ICAP of Forecast Peak	% UCAP of Forecast Peak
2006	584.2	689.4	651.9	118.0%	111.6%
2007	588.2	685.3	654.7	116.5%	111.3%
2008	579.1	666.0	627.5	115.0%	108.4%
2009	587.2	684.1	629.3	116.5%	107.2%
2010	317.6	374.8	337.0	118.0%	106.1%
2011	319.7	369.3	339.0	115.5%	106.0%
2012	576.1	668.3	606.9	116.0%	105.3%
2013	589.3	689.5	628.1	117.0%	106.6%
2014	506.3	592.4	538.6	117.0%	106.4%
2015	325.8	381.2	348.6	117.0%	107.0%
2016	336.0	394.8	356.9	117.5%	106.2%
2017	305.0	359.9	326.5	118.0%	107.0%
2018	327.6	387.2	354.1	118.2%	108.1%
2019	357.5	418.3	381.5	117.0%	106.7%
2020	392.7	466.9	428.2	118.9%	109.0%

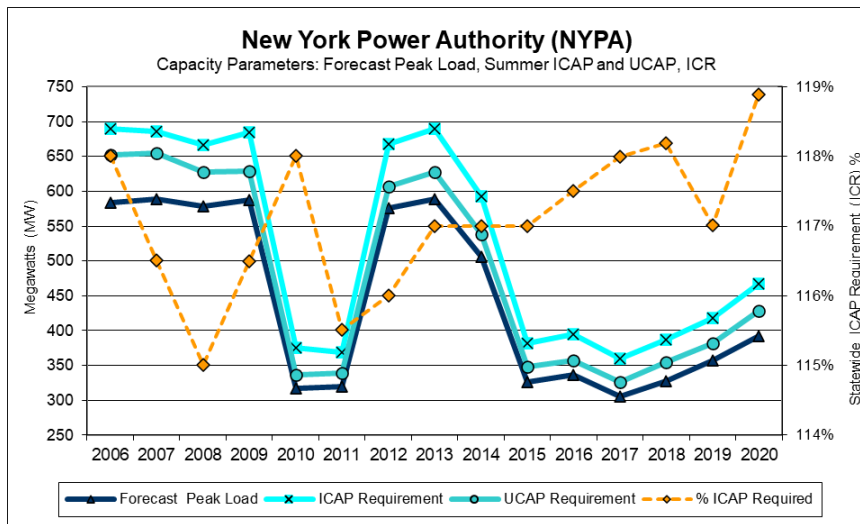

C.2.6 New York State Electric & Gas (NYSEG)

Table C.11 NYSEG ICAP to UCAP Translation

Year	Forecast Peak Load (MW)	ICAP Requirement (MW)	UCAP Requirement (MW)	% ICAP of Forecast Peak	% UCAP of Forecast Peak
2006	2,931.5	3,459.2	3,271.3	118.0%	111.6%
2007	3,216.9	3,747.7	3,580.5	116.5%	111.3%
2008	3,141.1	3,612.3	3,403.5	115.0%	108.4%
2009	3,111.8	3,625.3	3,334.9	116.5%	107.2%
2010	3,075.0	3,628.5	3,263.1	118.0%	106.1%
2011	3,037.0	3,507.7	3,220.1	115.5%	106.0%
2012	3,126.7	3,627.0	3,294.0	116.0%	105.4%
2013	3,113.4	3,642.7	3,318.1	117.0%	106.6%
2014	3,229.1	3,778.1	3,435.0	117.0%	106.4%
2015	3,179.8	3,720.4	3,402.7	117.0%	107.0%
2016	3,191.6	3,750.1	3,389.7	117.5%	106.2%
2017	3,222.9	3,803.0	3,449.7	118.0%	107.0%
2018	3,254.0	3,846.2	3,517.0	118.2%	108.1%
2019	3,146.6	3,681.5	3,357.9	117.0%	106.7%
2020	3,188.4	3,791.0	3,476.3	118.9%	109.0%

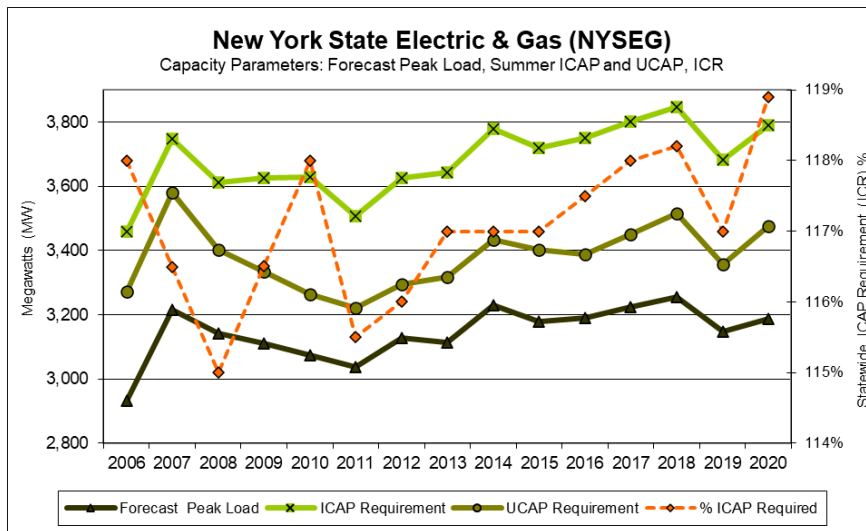

C.2.7 Orange & Rockland (O & R)

Table C.12 O & R ICAP to UCAP Translation

Year	Forecast Peak Load (MW)	ICAP Requirement (MW)	UCAP Requirement (MW)	%ICAP of Forecast Peak	%UCAP of Forecast Peak
2006	1,130.0	1,333.4	1,261.0	118.0%	111.6%
2007	1,131.5	1,318.2	1,259.4	116.5%	111.3%
2008	1,192.3	1,371.1	1,291.9	115.0%	108.4%
2009	1,179.5	1,374.1	1,264.0	116.5%	107.2%
2010	1,157.4	1,365.7	1,228.2	118.0%	106.1%
2011	1,172.7	1,354.5	1,243.4	115.5%	106.0%
2012	1,158.3	1,343.6	1,220.3	116.0%	105.4%
2013	1,171.7	1,370.9	1,248.7	117.0%	106.6%
2014	1,190.8	1,393.2	1,266.7	117.0%	106.4%
2015	1,162.2	1,359.8	1,243.7	117.0%	107.0%
2016	1,164.3	1,368.1	1,236.6	117.5%	106.2%
2017	1,177.3	1,389.2	1,260.2	118.0%	107.0%
2018	1,146.2	1,354.8	1,238.8	118.2%	108.1%
2019	1,115.5	1,305.1	1,190.4	117.0%	106.7%
2020	1,075.9	1,279.3	1,173.1	118.9%	109.0%

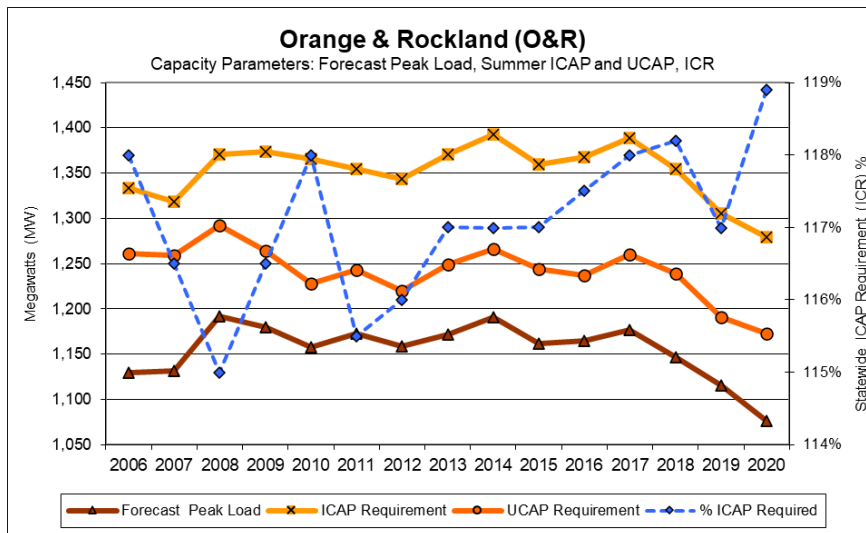

C.2.8 Rochester Gas & Electric (RGE)

Table C.13 RGE ICAP to UCAP Translation

Year	Forecast Peak Load (MW)	ICAP Requirement (MW)	UCAP Requirement (MW)	% ICAP of Forecast Peak	% UCAP of Forecast Peak
2006	1,628.5	1,921.6	1,817.3	118.0%	111.6%
2007	1,631.8	1,901.0	1,816.3	116.5%	111.3%
2008	1,649.4	1,896.8	1,787.2	115.0%	108.4%
2009	1,652.3	1,924.9	1,770.7	116.5%	107.2%
2010	1,629.7	1,923.0	1,729.4	118.0%	106.1%
2011	1,576.4	1,820.7	1,671.4	115.5%	106.0%
2012	1,612.3	1,870.3	1,698.6	116.0%	105.4%
2013	1,665.7	1,948.9	1,775.2	117.0%	106.6%
2014	1,599.6	1,871.5	1,701.6	117.0%	106.4%
2015	1,601.3	1,873.5	1,713.5	117.0%	107.0%
2016	1,590.8	1,869.2	1,689.6	117.5%	106.2%
2017	1,576.9	1,860.7	1,687.9	118.0%	107.0%
2018	1,594.3	1,884.5	1,723.1	118.2%	108.1%
2019	1,505.5	1,761.4	1,606.6	117.0%	106.7%
2020	1,543.3	1,835.0	1,682.7	118.9%	109.0%

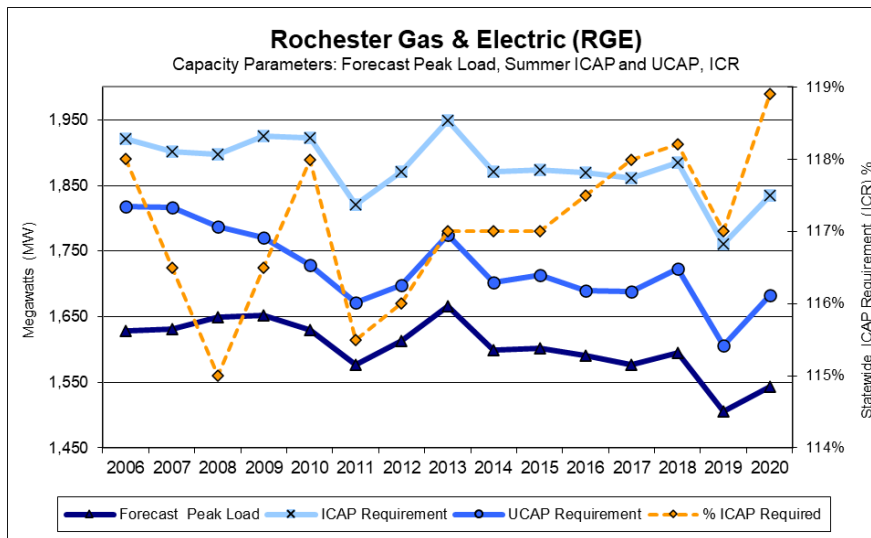

C.3 Wind Resource Impact on the NYCA IRM and UCAP Markets

Wind generation is generally classified as an "intermittent" or "variable generation" resource with a limited ability to be dispatched. The effective capacity of wind generation can be quantified and modeled using the GE-MARS program like conventional fossil-fired power plants. There are various modeling techniques to model wind generation in GE-MARS; the method that ICS has adopted uses historical New York hourly wind farm generation outputs for the previous five calendar years. This data can be scaled to create wind profiles for new wind generation facilities.

For a wind farm or turbine, the nameplate capacity is the ICAP while the effective capacity is equal to the UCAP value. Seasonal variability and geographic location are factors that also affect wind resource availability. The effective capacity of wind generation can be either calculated statistically directly from historical hourly wind generation outputs, and/or by using the following information:

- Production hourly wind data.
- Maintenance cycle and duration
- EFOR (not related to fuel)

In general, effective wind capacity depends primarily on the availability of the wind. Wind farms in New York on average have annual capacity factors that are based on their nameplate ratings. A wind plant's output can range from close to nameplate under favorable wind conditions to zero when the wind does not blow. On average, a wind plant's output is higher at night, and has higher output on average in the winter versus the summer.

Another measure of a wind generator's contribution to resource adequacy is its effective capacity which is its expected output during the summer peak hours of 2 p.m. to 6 p.m. for the months of June through August. The effective capacity value for wind generation in New York is based on actual hourly plant output over the previous five-year period – [2014-2015](#) through [2018-2019](#) for this year's study, for new units the zonal hourly averages or averages for nearby units will be used. Wind shapes years are selected randomly from those years for each simulation year.

Appendix D

Glossary of Terms

D. Glossary

Term	Definition
Availability	A measure of time a generating unit, transmission line, or other facility can provide service, whether or not it actually is in service. Typically, this measure is expressed as a percent available for the period under consideration.
Bubble	A symbolic representation introduced for certain purposes in the GE-MARS model as an area that may be an actual zone, multiple areas or a virtual area without actual load.
Capability Period	Six (6) month periods which are established as follows: (1) from May 1 through October 31 of each year ("Summer Capability Period"); and (2) from November 1 of each year through April 30 of the following year ("Winter Capability Period"); or such other periods as may be determined by the Operating Committee of the NYISO. A summer capability period followed by a winter capability period shall be referred to as a "Capability Year." Each capability period shall consist of on-peak and off-peak periods.
Capacity	The rated continuous load-carrying ability, expressed in megawatts ("MW") or megavolt-amperes ("MVA") of generation, transmission or other electrical equipment.
Contingency	An actual or potential unexpected failure or outage of a system component, such as a generator, transmission line, circuit breaker, switch, or other electrical element. A contingency also may include multiple components, which are related by situations leading to simultaneous component outages.
Control Area (CA)	An electric system or systems, bounded by interconnection metering and telemetry, capable of controlling generation to maintain its interchange schedule with other control areas and contributing to frequency regulation of the interconnection.
Demand	The rate at which energy must be generated or otherwise provided to supply an electric power system.
Emergency	Any abnormal system condition that requires automatic or immediate, manual action to prevent or limit loss of transmission facilities or generation resources that could adversely affect the reliability of an electric system.
Energy Limited Resource (ELR)	Capacity resources, not including BTM:NG Resources, that, due to environmental restrictions on operations, cyclical requirements, such as the need to recharge or refill, or other non-economic reasons, are unable to operate continuously on a daily basis, but are able to operate for at least four consecutive hours each day.
External Installed Capacity (External ICAP)	Installed capacity from resources located in control areas outside the NYCA that must meet certain NYISO requirements and criteria in order to qualify to supply New York LSEs.
Firm Load	The load of a Market Participant that is not contractually interruptible. Interruptible Load – The load of a Market Participant that is contractually interruptible.
Generation	The process of producing electrical energy from other forms of energy; also, the amount of electric energy produced, usually expressed in kilowatt-hours (kWh) or megawatt-hours (MWh).

Term	Definition
Installed Capacity (ICAP)	Capacity of a facility accessible to the NYS Bulk Power System, that is capable of supplying and/or reducing the demand for energy in the NYCA for the purpose of ensuring that sufficient energy and capacity is available to meet the reliability rules.
Installed Capacity Requirement (ICR)	The annual statewide requirement established by the NYSRC in order to ensure resource adequacy in the NYCA.
Installed Reserve Margin (IRM)	That capacity above firm system demand required to provide for equipment forced and scheduled outages and transmission capability limitations.
Interface	The specific set of transmission elements between two areas or between two areas comprising one or more electrical systems.
Load	The electric power used by devices connected to an electrical generating system. (IEEE Power Engineering)
Load Relief	Load reduction accomplished by voltage reduction or load shedding or both. Voltage reduction and load shedding, as defined in this document, are measures by order of the NYISO.
Load Shedding	The process of disconnecting (either manually or automatically) pre-selected customers' load from a power system in response to an abnormal condition to maintain the integrity of the system and minimize overall customer outages. Load shedding is a measure undertaken by order of the NYISO. If ordered to shed load, transmission owner system dispatchers shall immediately comply with that order. Load shall normally all be shed within 5 minutes of the order.
Load Serving Entity (LSE)	In a wholesale competitive market, Central Hudson Gas & Electric Corporation, Consolidated Edison Company of New York, Inc., Long Island Power Authority ("LIPA"), New York State Electric & Gas Corporation, Niagara Mohawk Power Corporation, Orange & Rockland Utilities, Inc., and Rochester Gas and Electric Corporation, the current forty-six (46) members of the Municipal Electric Utilities Association of New York State, the City of Jamestown, Rural Electric Cooperatives, the New York Power Authority ("NYPA"), any of their successors, or any entity through regulatory requirement, tariff, or contractual obligation that is responsible for supplying energy, capacity and/or ancillary services to retail customers within New York State.
Locational Capacity Requirement (LCR)	Due to transmission constraints, that portion of the NYCA ICAP requirement that must be electrically located within a zone, in order to ensure that sufficient energy and capacity are available in that zone and that NYSRC Reliability Rules are met. Locational ICAP requirements are currently applicable to three transmission constrained zones, New York City, Long Island, and the Lower Hudson Valley, and are normally expressed as a percentage of each zone's annual peak load.
New York Control Area (NYCA)	The control area located within New York State which is under the control of the NYISO. See Control Area.

Term	Definition
New York Independent System Operator (NYISO)	The NYISO is a not-for-profit organization formed in 1998 as part of the restructuring of New York State's electric power industry. Its mission is to ensure the reliable, safe and efficient operation of the State's major transmission system and to administer an open, competitive and nondiscriminatory wholesale market for electricity in New York State.
New York State Bulk Power System (NYS Bulk Power System or BPS)	The portion of the bulk power system within the New York Control Area, generally comprising generating units 300 MW and larger, and generally comprising transmission facilities 230 kV and above. However, smaller generating units and lower voltage transmission facilities on which faults and disturbances can have a significant adverse impact outside of the local area are also part of the NYS Bulk Power System.
New York State Reliability Council, LLC (NYSRC)	An organization established by agreement (the "NYSRC Agreement") by and among Central Hudson Gas & Electric Corporation, Consolidated Edison Company of New York, Inc., LIPA, New York State Electric & Gas Corporation, Niagara Mohawk Power Corporation, Orange & Rockland Utilities, Inc., Rochester Gas and Electric Corporation, and the New York Power Authority, to promote and maintain the reliability of the Bulk Power System, and which provides for participation by Representatives of Transmission Owners, sellers in the wholesale electric market, large commercial and industrial consumers of electricity in the NYCA, and municipal systems or cooperatively-owned systems in the NYCA, and by unaffiliated individuals.
New York State (NYS) Transmission System	The entire New York State electric transmission system, which includes: (1) the transmission facilities under NYISO operational control; (2) the transmission facilities requiring NYISO notification, and; (3) all remaining facilities within the NYCA.
Operating Limit	The maximum value of the most critical system operation parameter(s) which meet(s): (a) pre-contingency criteria as determined by equipment loading capability and acceptable voltage conditions; (b) stability criteria; (c) post-contingency loading and voltage criteria.
Operating Procedures	A set of policies, practices, or system adjustments that may be automatically or manually implemented by the system operator within a specified time frame to maintain the operational integrity of the interconnected electric systems.
Operating Reserves	Resource capacity that is available to supply energy, or curtailable load that is willing to stop using energy, in the event of emergency conditions or increased system load, and can do so within a specified time period.
Reserves	In normal usage, reserve is the amount of capacity available in excess of the demand.
Resource	The total contributions provided by supply-side and demand-side facilities and/or actions.
Stability	The ability of an electric system to maintain a state of equilibrium during normal and abnormal system conditions or disturbances.
Thermal Limit	The maximum power flow through a particular transmission element or interface, considering the application of thermal assessment criteria.
Transfer Capability	The measure of the ability of interconnected electrical systems to reliably move or transfer power from one area to another over all transmission lines (or paths) between those areas under specified system conditions.

Term	Definition
Transmission District	The geographic area served by the NYCA investor-owned transmission owners and LIPA, as well as customers directly interconnected with the transmission facilities of NYPA.
Transmission Owner	Those parties who own, control and operate facilities in New York State used for the transmission of electric energy in interstate commerce. Transmission owners are those who own, individually or jointly, at least 100 circuit miles of 115 kV or above in New York State and have become a signatory to the TO/NYISO Agreement.
Unforced Capacity:	The measure by which Installed Capacity Suppliers will be rated, in accordance with formulae set forth in the ISO Procedures, to quantify the extent of their contribution to satisfy the NYCA Installed Capacity Requirement, and which will be used to measure the portion of that NYCA Installed Capacity Requirement for which each LSE is responsible.
Voltage Limit	The maximum power flow through some particular point in the system considering the application of voltage assessment criteria.
Voltage Reduction	A means of achieving load reduction by reducing customer supply voltage, usually by 3, 5, or 8 percent. If ordered by the NYISO to go into voltage reduction, Transmission Owner system dispatchers shall immediately comply with that order. Quick response voltage reduction shall normally be accomplished within ten (10) minutes of the order.
Zone	A defined portion of the NYCA area that encompasses a set of load and generation buses. Each zone has an associated zonal price that is calculated as a weighted average price based on generator LBMPs and generator bus load distribution factors. A "zone" outside the NY control area is referred to as an external zone. Currently New York State is divided into eleven zones, corresponding to ten major transmission interfaces that can become congested.